

ASCON spa

ISO 9001
Certified

ASCON spa
via Falzarego, 9/11
20021 Baranzate
(Milano) Italy
Fax +39-02-3504243
www.ascon.it
support@ascon.it

ASCON CORPORATION
1884 East Fabyan Parkway
Batavia, Illinois 60510
Tel. +1-630-482-2950
Fax +1-630-482-2956
www.asconcorp.com
info@asconcorp.com

Indicator - Transmitter Strain Gauge Input for Melt Pressure & Load Cell Transducers 1/8 DIN - 96x48

J5 line

User Manual • M.I.U.J5 - 0/08.08 • Cod. J30-478-1AJ5 E



**Indicator - Transmitter
Strain Gauge Input for
Melt Pressure &
Load Cell Transducers
1/8 DIN - 96x48
J5 line**

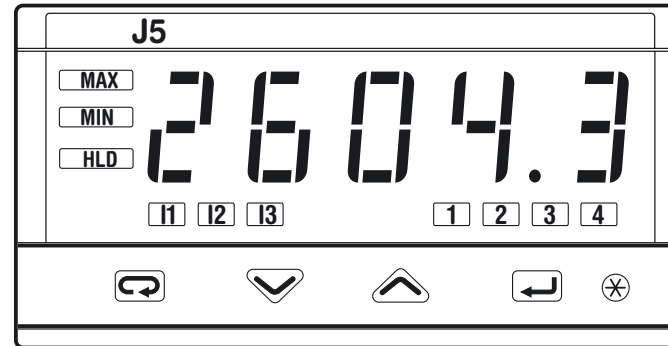



NOTES

ON ELECTRIC SAFETY AND ELECTROMAGNETIC COMPATIBILITY

Please read these instructions carefully before proceeding with the installation of the controller.

Class II instrument, rear panel mounting.

This indicator has been designed in compliance with:

Regulations on electrical apparatus (appliance, systems and installations) according to the European Community directive 73/23/EEC amended by the European Community directive 93/68/EEC and the Regulations on the essential protection requirements in electrical apparatus EN61010-1 : 93 + A2:95.

Regulations on Electromagnetic Compatibility according to the European Community directive #89/336/EEC, amended by the European Community directive #92/31/EEC, 93/68/EEC, 98/13/EEC and the following regulations:

Regulations on RF emissions

EN61000-6-3 : 2001 residential environments

EN61000-6-4 : 2001 industrial environments

Regulation on RF immunity

EN61000-6-2 : 2001 industrial equipment and system

It is the responsibility of the installer to ensure compliance with the regulations on safety requirements and EMC.

The device has no user serviceable parts and requires special equipment for repair.

For service or repair, contact the manufacturer or your sales representative.

All the information and warnings about safety and electromagnetic compatibility are marked with the   sign, at the side of the note.

TABLE OF CONTENTS

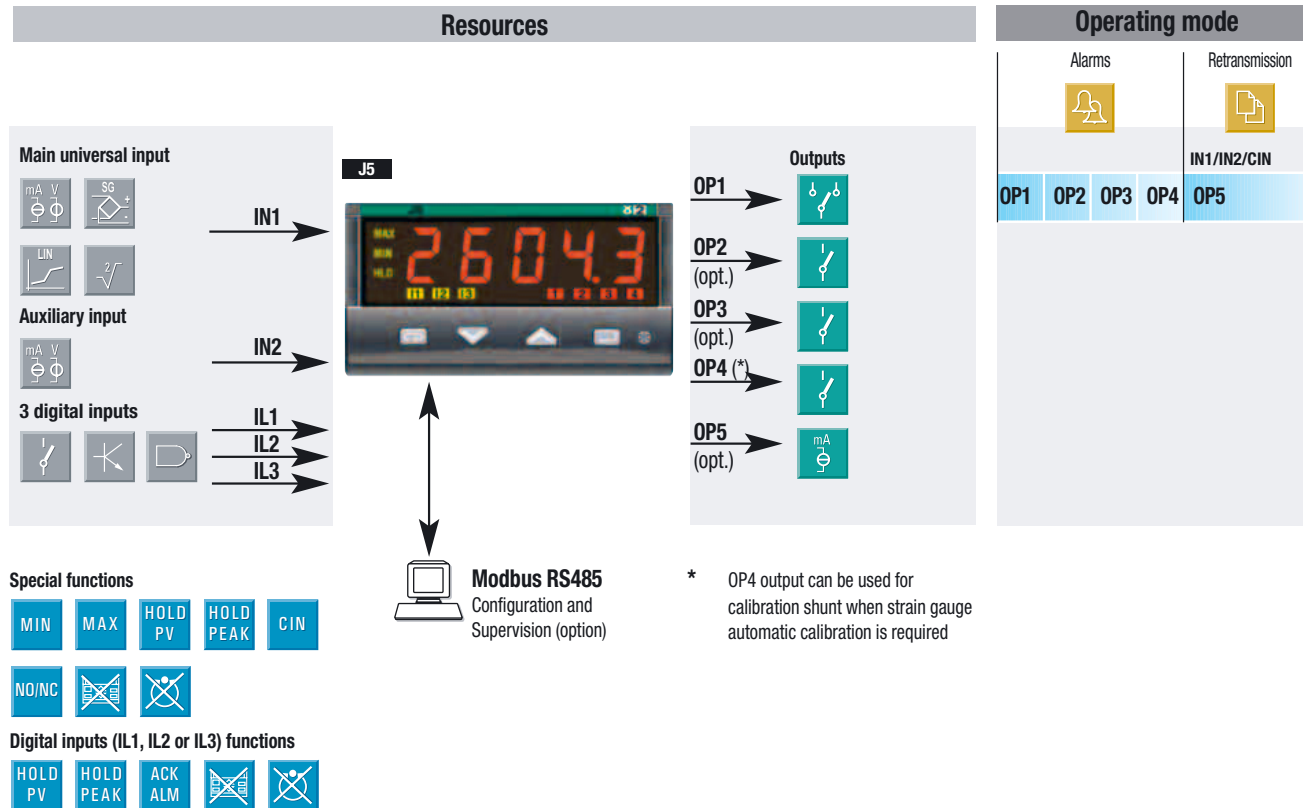

1	INSTALLATION	Page 4
2	ELECTRICAL CONNECTIONS	Page 8
3	PRODUCT CODING	Page 14
4	OPERATION	Page 18
5	DISPLAYS	Page 34
6	COMMANDS	Page 35
7	TECHNICAL SPECIFICATIONS	Page 37

1 INSTALLATION

Installation must be carried out only by qualified personnel.

Before proceeding with the installation of this indicator read the instructions in this manual with particular attention to the installation precautions marked with the  symbol.



To prevent contact with parts that may be electrically live, **the indicator must be installed in an enclosure.**

1.1 GENERAL DESCRIPTION

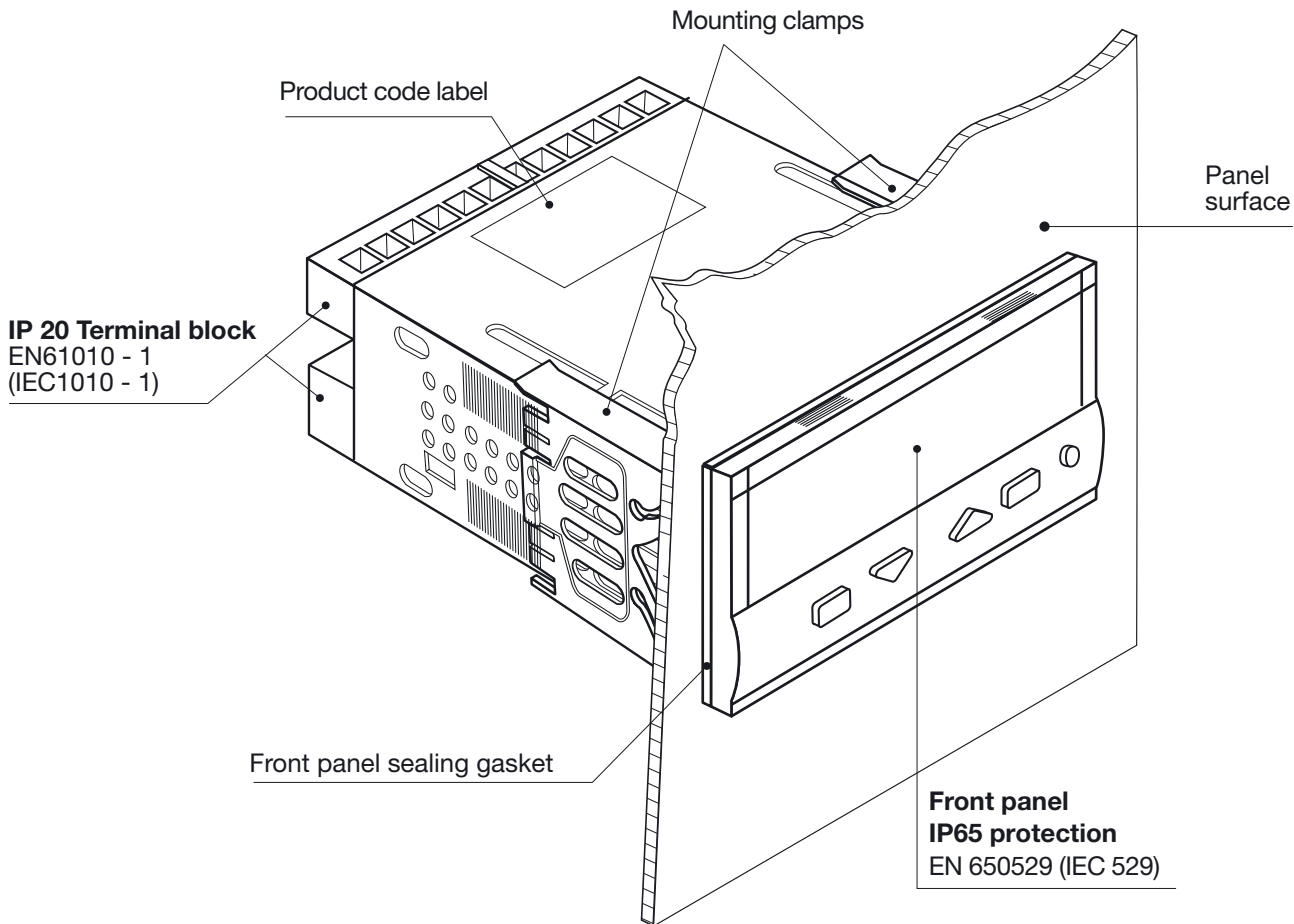

1.2 DIMENSIONS

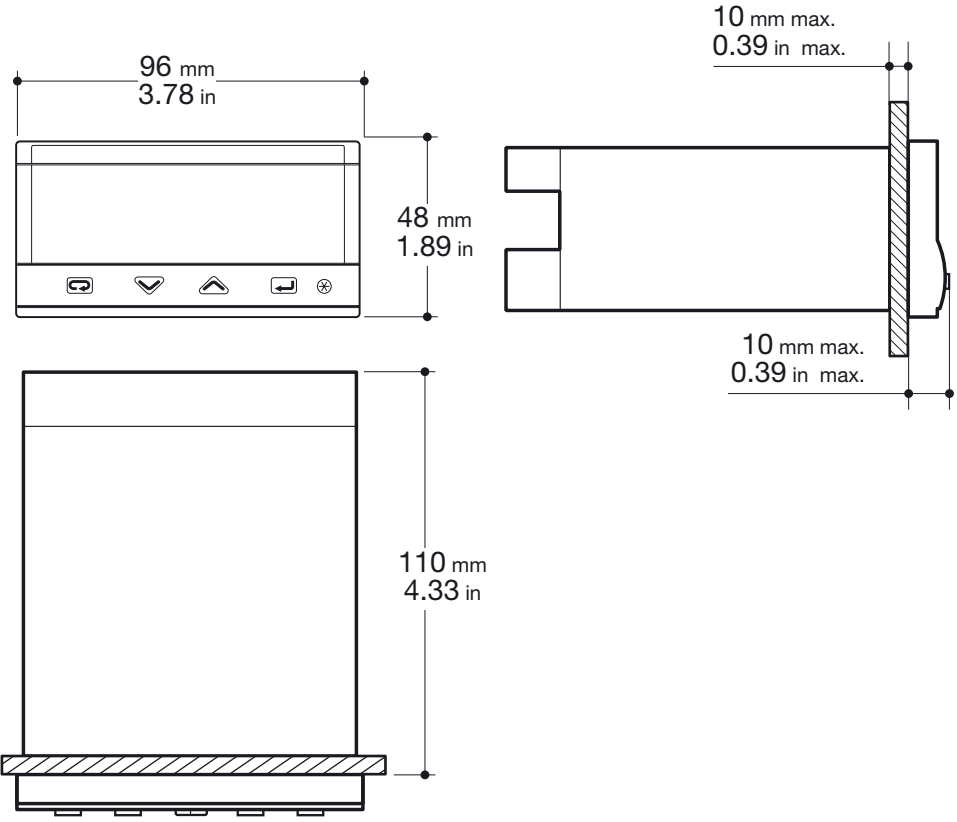

1.3 PANEL CUTOUT

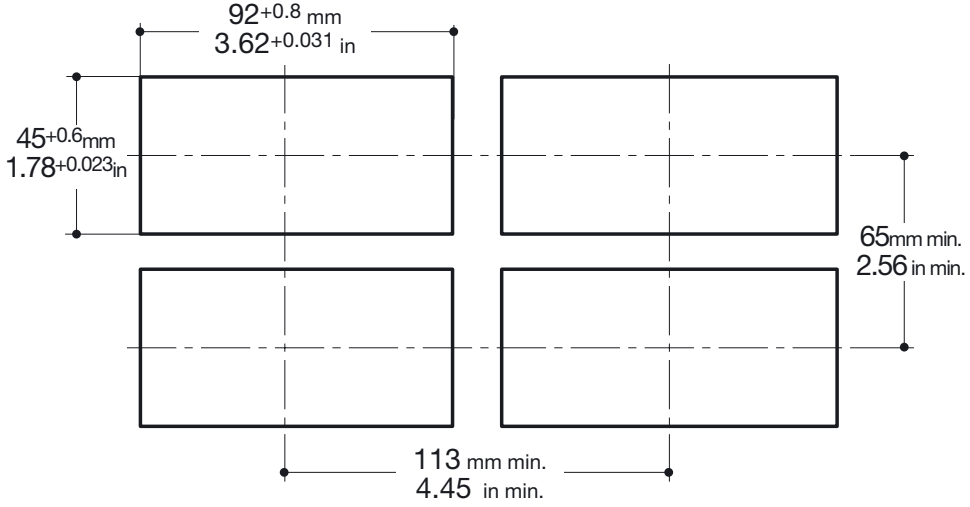

1.4 ENVIRONMENTAL CONDITIONS



Operating conditions



Altitude: up to 2000 m



Temperature: 0...50°C

%Rh

Relative humidity: 5...95 % non-condensing

Special conditions

Suggestions



Altitude: > 2000 m

Use 24Vac supply version



Temperature: >50°C

Use forced air ventilation

%Rh

Humidity: > 95 %

Warm up



Conducting atmosphere

Use filter

Prohibited Conditions



Corrosive atmosphere



Explosive atmosphere

1.5 PANEL MOUNTING [1]

1.5.1 INSERT THE INSTRUMENT

- 1 Prepare panel cutout
- 2 Check front panel gasket position
- 3 Insert the instrument through the cutout

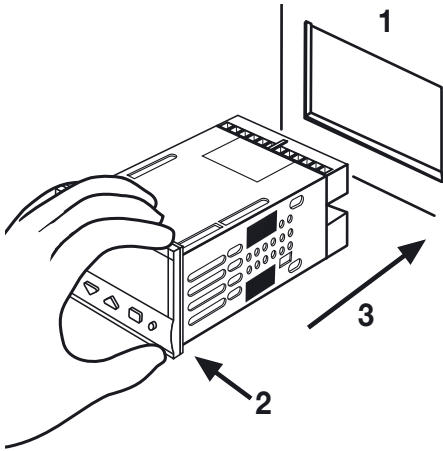

1.5.2 INSTALLATION SECURING

- 1 Attach the mounting clamps as shown
- 2 Push the mounting clamps toward the panel surface to secure the instrument

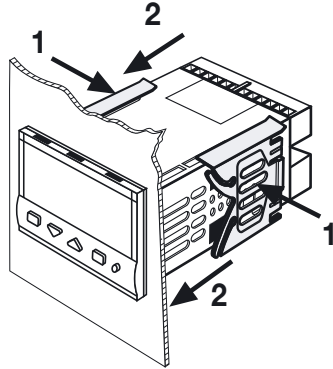

1.5.3 CLAMP REMOVAL

- 1 Insert the screwdriver in the clips of each clamp
- 2 Rotate the screwdriver

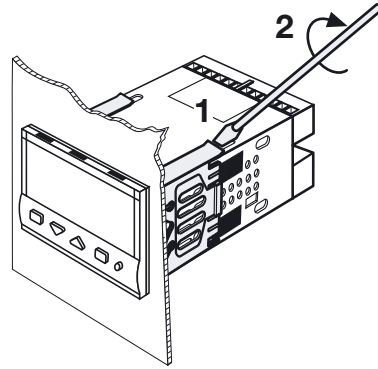

1.5.4 INSTRUMENT REMOVAL



- 1 Push and ...
- 2 Pull forward to remove the instrument

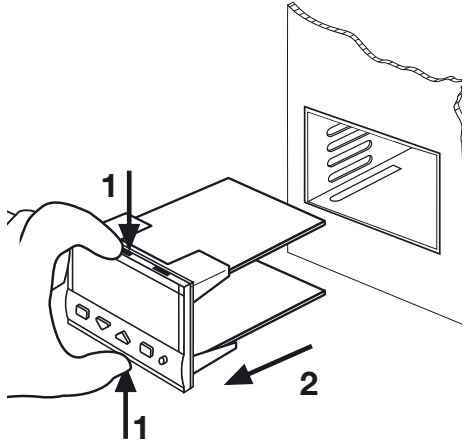

Electrostatic discharges can damage the instrument. Before removing the instrument, the operator must discharge himself

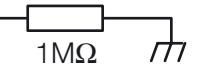

UL note

[1] For Use on a Flat Surface of a Type 2 and Type 3 'raintight' Enclosure.

ELECTRICAL CONNECTIONS

2.1 TERMINAL BLOCK [1]

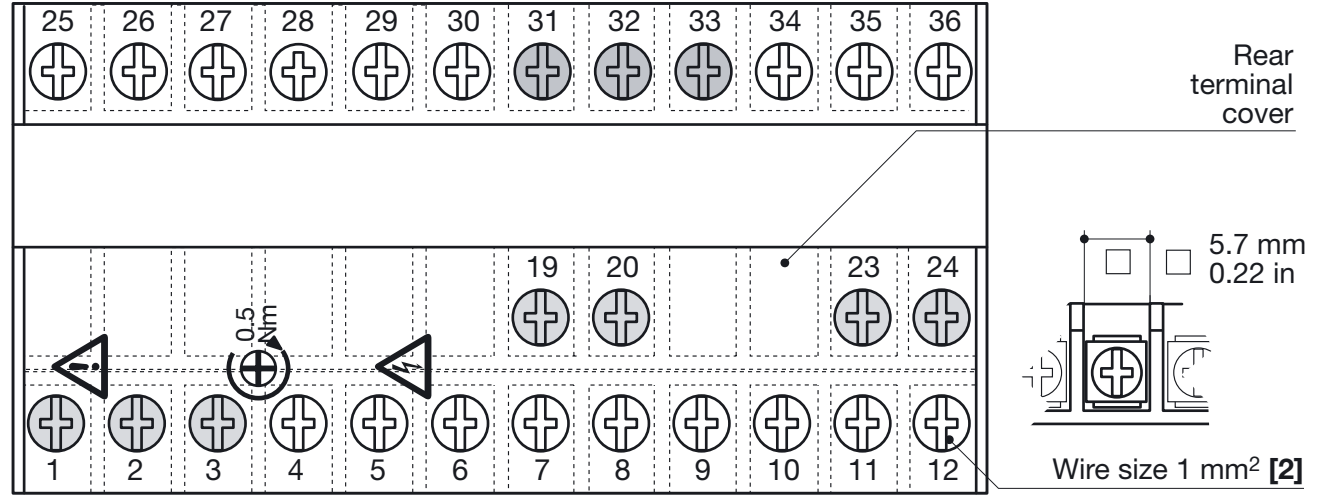
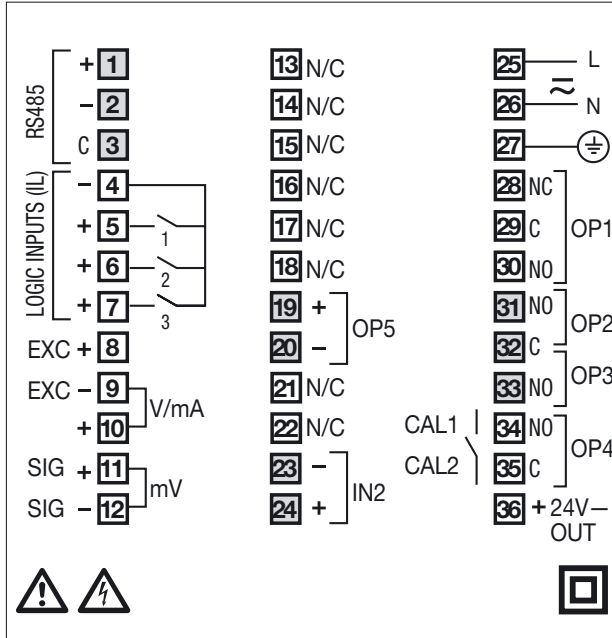

UL note

- [1] Use 60/70 °C copper (Cu) conductor only.
- [2] Wire size 1 mm² (18 AWG Solid/Stranded)

- 28 screw terminals M3
- Option terminals
- Tightening torque 0.5 Nm
- Phillips screw-driver PH1
- Flat head screw-driver 0.8 x 4 mm

Terminals

- Pin connector
∅ 1.4 mm 0.055 in max.
- Fork-shape AMP 165004
∅ 5.5 mm - 0.21 in
- Stripped wire
L 5.5 mm - 0.21 in

PRECAUTIONS

This instrument has been designed to work in harsh and noisy environments (level IV of the industrial standard IEC 801-4). It is recommended to follow these suggestions.



All the wiring must comply with local regulations.

The supply wiring should be routed away from the power cables. Avoid using electromagnetic contactors, power relays, and high power motors in close proximity. Avoid power units in close proximity, especially if controlled in phase angle mode.

Keep low level sensor input wires away from the power lines and output wires.

If this is not possible, use shielded cables on the sensor input, with the shield connected to ground.

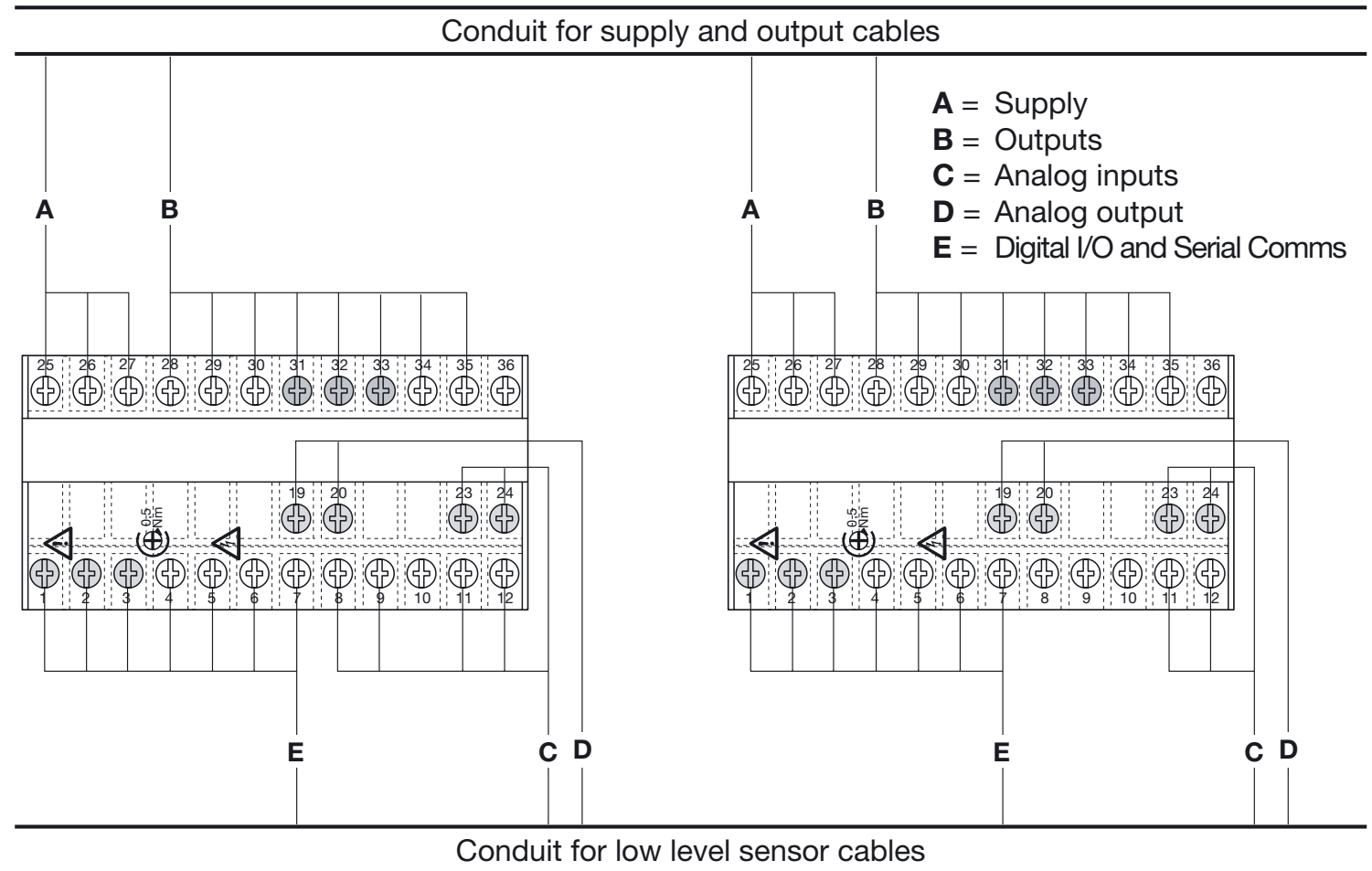
2.2 SUGGESTED WIRE ROUTING

2.3.1 POWER SUPPLY

Switching power supply with multiple isolation and internal PTC protection.

- **Standard version:**
nominal voltage:
100...240Vac (-15...+10%)
Frequency 50/60Hz
- **Low Voltage version:**
Nominal voltage:
24Vac (-25...+12%)
Frequency 50/60Hz
or 24Vdc (-15...+25%)

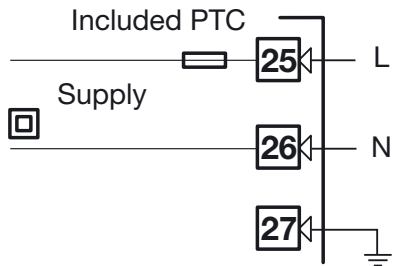

For better protection against noise, it is recommended to not connect the ground clamp provided for domestic installations.

2.3.2 MAIN INPUT (IN1)

A1 For mV

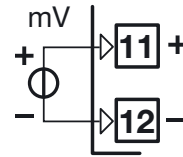

A2 4 wire Strain Gauge Input

- Set code **L** = 1 or 2 (see page 16) to obtain 5 or 10 Vdc stabilized power supply for the external strain gauge bridge, terminals 8 (+) and 9 (-).
- Set code **I** = 0, 1 or 2 (see page 16) to obtain suitable mV input (20, 520 or 100 mV), terminals 11 (+) and 12 (-).

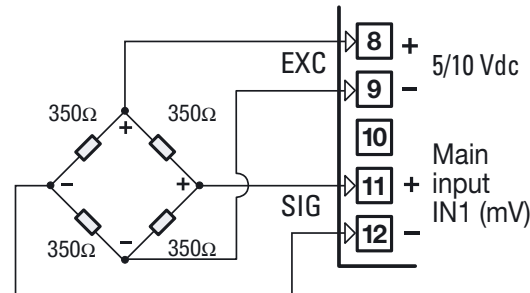

Configuration example:

- For strain gauge transducer rated 350Ω, 3.3 mV/V, 10 V excitation Voltage, select: **I** : 1, **L** : 2;

A3 6 wire Strain Gauge Input

- Set code **L** = 1 or 2 (see page 16) to obtain 5 or 10 Vdc stabilized power supply for the external strain gauge bridge, terminals 8 (+) and 9 (-).
- Set code **I** = 0, 1 or 2 (see page 16) to obtain suitable mV input (20, 50 or 100 mV), terminals 11 (+) and 12 (-).
- The calibration wires of the transducer must be connected to CAL terminals 34 and 35 (OP4 Output).

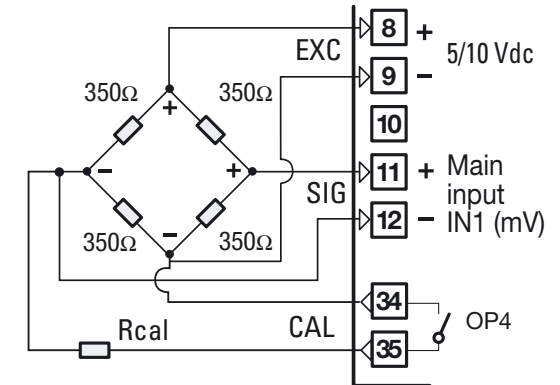

Note:

The excitation current of the strain gauge transducer must not exceed 30 mA.

B For mA, V

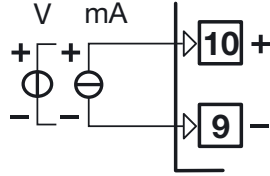

R_j >10MΩ.

B1 With 2 wire transmitter

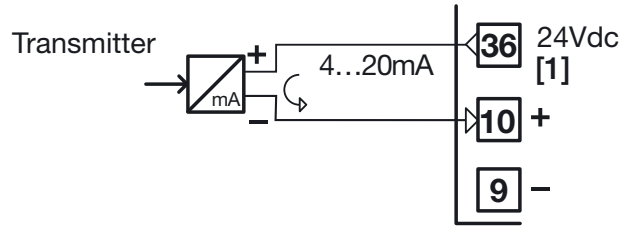

B2 With 3 wire transmitter

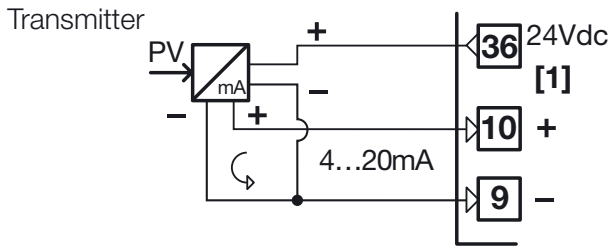

Note:

[1] Auxiliary power supply for external transmitter 24Vdc ±20% /30mA max. with no short circuit protection

2.3.3 AUXILIARY INPUT (IN2) (OPTION)



For mA and V

Current 0/4...20mA
 Input resistance = 50Ω
 Voltage:1...5V, 0...5V, 0...10V
 Input resistance = 150kΩ

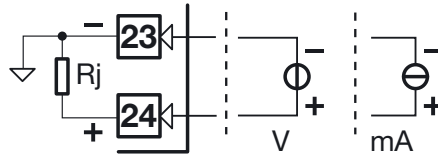

2.3.4 DIGITAL INPUTS



- The input is active when the logic state is ON, corresponding to the contact closed
- The input is inactive when the logic state is OFF, corresponding to the contact open

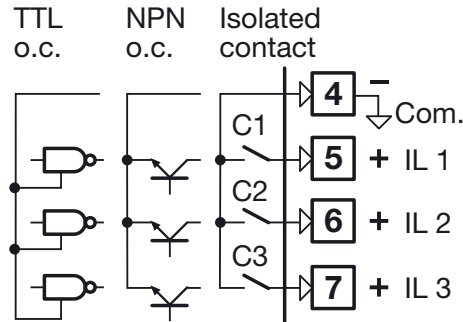

2.3.5 OP1 - OP2 (OPT.) - OP3 (OPT.) - OP4 OUTPUTS



OP1	SPDT relay output
OP2 - OP3	SPST-NO relay outputs
OP4	SPST-NO relay output
OP5	Retransmission analog output

OP1 relay output:

- SPDT relay,
 2A/250Vac for resistive loads;
 OP protection: use a 2AT at 250Vac fuse (for 4A/120Vac use a 4AT at 120Vac fuse).

OP2 - OP3 relay outputs

- SPST N.O. relay,
 2A/250Vac for resistive loads;
 OP protection: use a 2AT at 250Vac fuse (for 4A/120Vac use a 4AT at 120Vac fuse).

OP4 Relay output

- SPST relay N.O.,
 2A/250Vac for resistive loads;
 OP protection: use a 2AT at 250Vac fuse (for 4A/120Vac use a 4AT at 120Vac fuse).

OP5 isolated analog output

- 0/4...20mA, 750Ω/15V max..

2.3.6 ALARM OUTPUTS



OP1 output

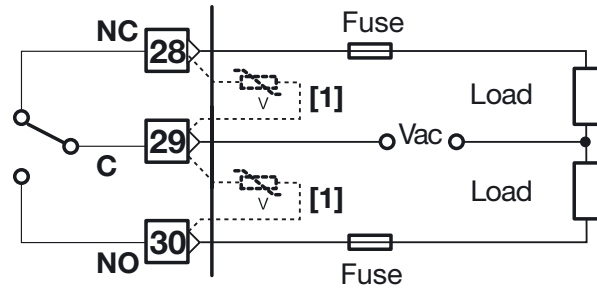

OP2, OP3 Outputs (opt.)

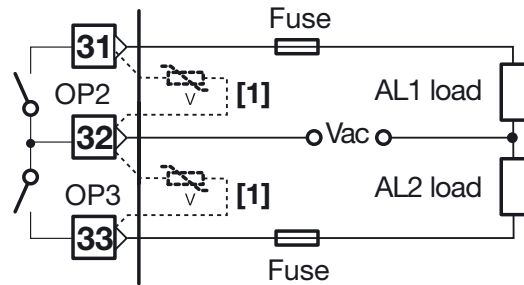

OP4 output

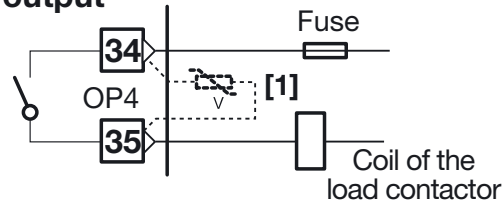

Notes:

[1] Varistor for inductive load 24Vac only;

2.3.7 OP5 ANALOG RETRANSMISSION OUTPUT (OPTION)



To retransmit one of the following values:
IN1, IN2 or computed (conditioned) signal.

- Galvanic isolation 500Vac/1 min.
- 0/4...20mA, (750Ω or 15Vdc max.)

2.3.8 SERIAL COMMUNICATIONS (OPTION)

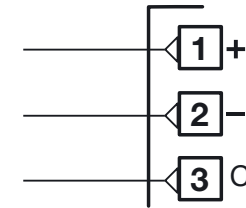

- Galvanic isolation 500Vac/1 min.
- Compliance to the EIA RS485 standard for Modbus/Jbus
- Setting dip switches

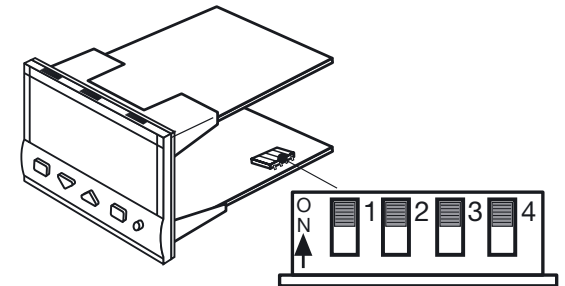

⚠ Please, read: “**gammadue**® and **deltadue**® series serial communication and configuration software” technical manual

3 PRODUCT CODING

The complete code is shown on the instrument label.

Information about product coding is accessible from the front panel by means of the procedure described in section 5.2 page 43.

Configuration code (software)

Basic product code (hardware)

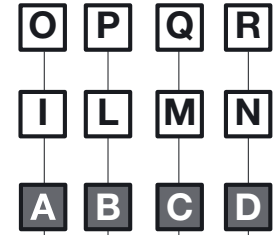

Instrument label

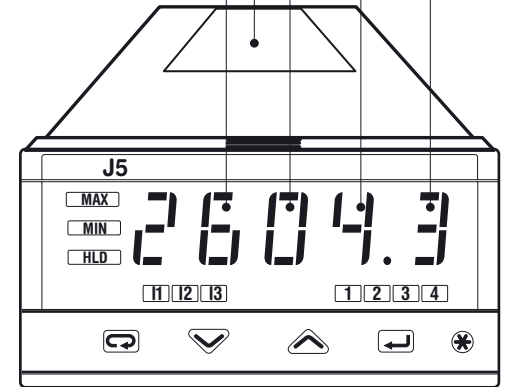
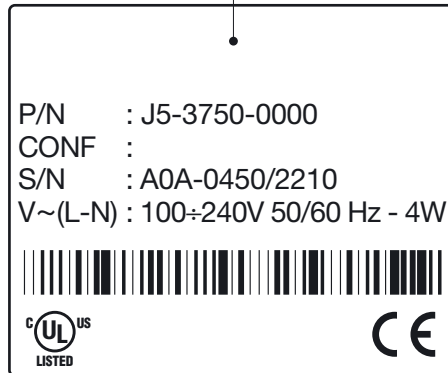

3.1 MODEL CODE

The product code indicates the specific hardware of the instrument.

Model:	Line	Basic	Accessories	Configuration	
				1st part	2nd part
	J 5	A B C D	0 F 0 0	I L M N	O P Q R

Line	J 5
-------------	------------

Power supply	A
100...240Vac (-15...+10%)	3
24Vac (-25...+12%) or 24Vdc (-15...+25%)	5

Outputs OP1 - OP2 - OP3 - OP4	B
Relay / - / - / Relay	7
Relay - Relay - Relay - Relay	9

Serial Communications	C
None	0
RS485 Modbus/Jbus SLAVE	5

Options	D
None	0
Analog output for signal retransmission	1
Second input IN2	2
Analog output + Second input IN2	5

User manual	F
English (std)	8

3.2 CONFIGURATION CODING

A 4+4 index code follows the model of the indicator.
The code has to be set to configure the indicator
(see chapter 3.1 page 15)

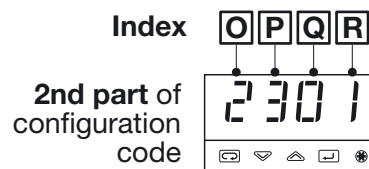
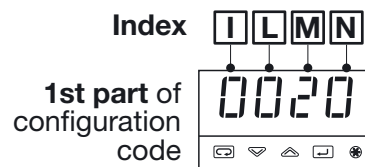

E.g.: Enter the code **0020** to choose:

- Dc input 0...20 mV;
- Change the display color to red when AL1 is active;
- Peak hold disabled.

E.g.: Enter the code **2301** to choose:

- AL1 absolute, active high;
- AL2 absolute, active low;
- AL3 disabled;
- AL4 sensor break alarm.

IN1 Input range	IN1 Input Type	I	L
DC input 0... 20 mV	Linear	0	0
DC input 0... 50 mV		1	0
DC input 0... 100 mV		2	0
DC input 0... 1 V		3	0
DC input 0... 5 V		4	0
DC input 1... 5 V		5	0
DC input 0... 10 V		6	0
DC input 0... 20 mA		7	0
DC input 4... 20 mA	8	0	
DC input 0... 20 mV	Strain gauge 5 V bridge excitation voltage	0	1
DC input 0... 50 mV		1	1
DC input 0... 100 mV		2	1
DC input 0... 20 mV	Strain gauge 10 V bridge excitation voltage	0	2
DC input 0... 50 mV		1	2
DC input 0... 100 mV		2	2

Notes:

- 1] Selecting for code **I** a value between 0... 3 the instrument uses, for the measurement, terminals 11 and 12. The other measurements (**I** values between 4... 8) are made using terminals 9 and 10.
- 2] To use a strain gauge input, select the bridge excitation voltage of the transducer. This selection is valid only if IN1 input range (code **I**) is set for mV input (codes 0... 2).
- 3] Selecting the strain gauge input enables the transducer excitation power supply, dedicated sensor break diagnostic routines (on terminals 8, 9, 11, 12) and a specific strain gauge menu. The bridge excitation voltage (5/10Vdc) is present on terminals 8, 9 when **L** = 1/2.

Display mode	M
Green	0
Red	1
Red when alarm 1 (AL1) active	2
Red when at least 1 alarm is active (alarm OR)	3
Alternate between IN1, IN2 and CIN value	4
Manual forced display of IN1, IN2, CIN, Lo, Hi and Unit value	5

Hold of the peak values	N
Disabled	0
Shows the max. value (HI peak) for a programmable period of time	1
Shows the min. value (LO peak) for a programmable period of time	2

Alarm type and function		O	P	Q	R
		AL1	AL2	AL3	AL4
Non-active		0			
Sensor or strain gauge break alarm		1			
Absolute	Active High	2			
	Active Low	3			
Deviation	Active High	4			
	Active Low	5			
Band	Active Out	6			
	Active In	7			
Rate alarm (AL1 only)		8	-		

4 OPERATIONS

4.1.1 KEY FUNCTIONS AND DISPLAY IN OPERATOR MODE

Display mode of the Peak values

MAX or MIN LEDs will be visible when the display shows a minimum or a maximum value. HLD LED will be visible when the value displayed is locked by the HOLD command. HOLD and PEAK commands stop the measurement procedure, while the PEAK VALUES HOLD command returns to normal operation after a programmed period of time (*HLD dtn* parameter).

Digital input status LEDs (yellow)

- I 1 - IL1 active
- I 2 - IL2 active
- I 3 - IL3 active

Menu access

Min. and Max. values display

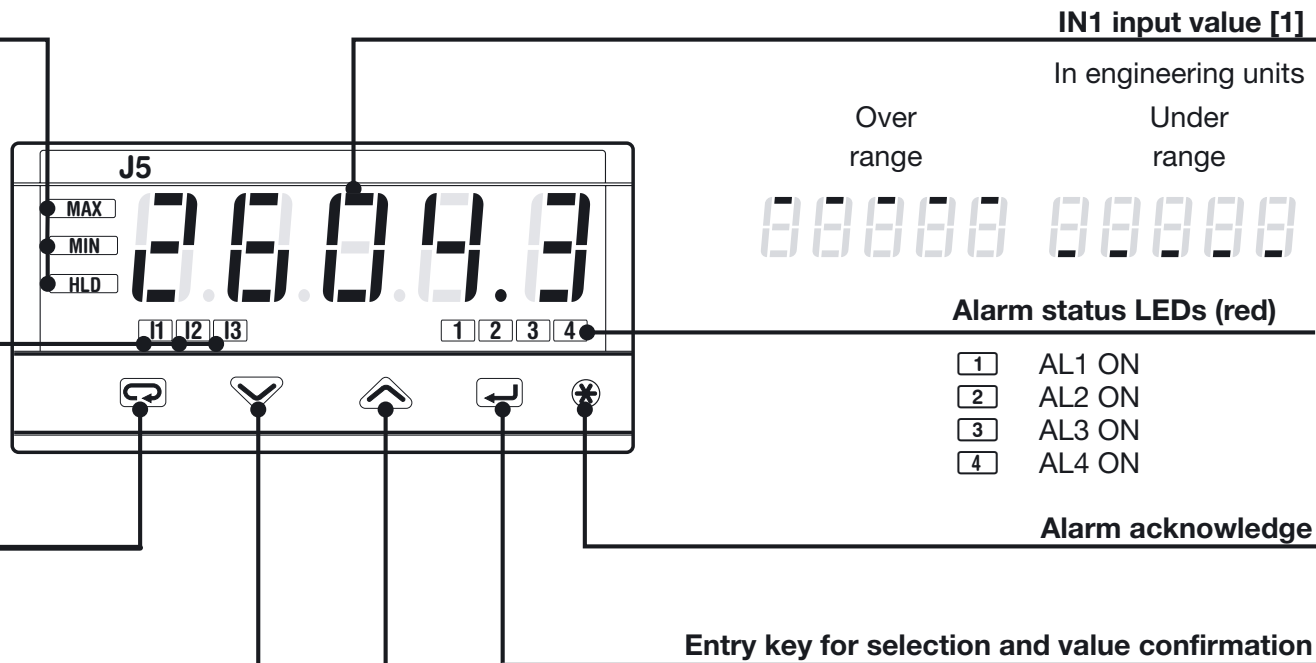



Note:

[1] The color of the display is set through field **M** of the Configuration Code (page 17).



4.1.2 KEY FUNCTIONS AND DISPLAY IN PROGRAMMING MODE



The parameter setting procedure has a timeout. If no keys are pressed for at least 30 seconds, the indicator automatically switches back to the operator mode. During the configuration procedure, the indicator does not exit the procedure for timeout.

After having selected the parameter or the code, press  or  to display or modify the value (see page 25).

The value is entered when the next parameter is selected, by pressing the  key.

Until the  or  are pressed, or if you wait for 30 seconds, the parameter value is not entered.

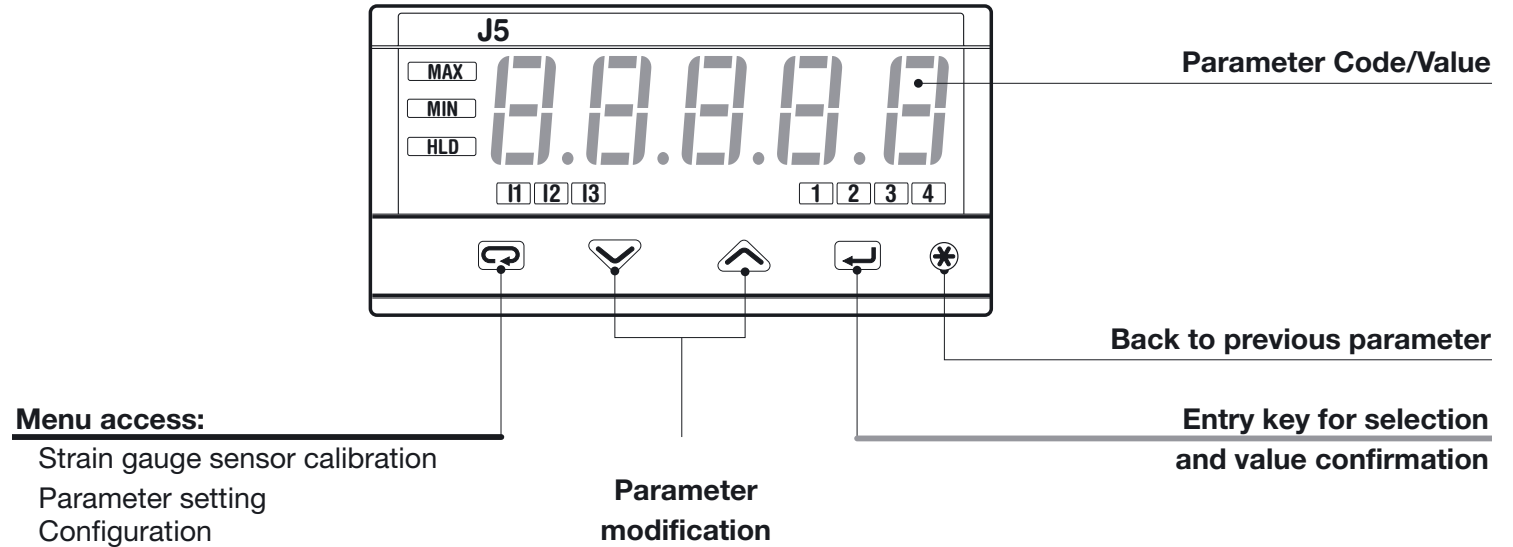

Pressing the  key, the next group of parameters is shown on the display.





4.2 PARAMETER SETTING

4.2.1 NUMERIC ENTRY

(i.e. insert `Code3` password)

Pressing  or  momentarily changes the value by 1 unit every push.

Continued pressing of  or  changes first the unit value, then the value of the second digit, the third and so on.

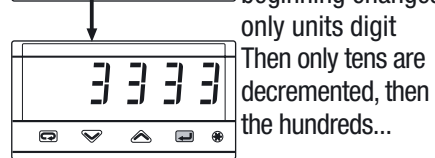
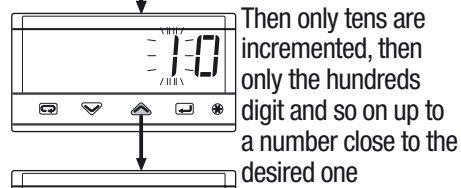
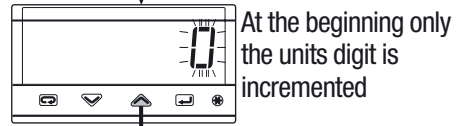
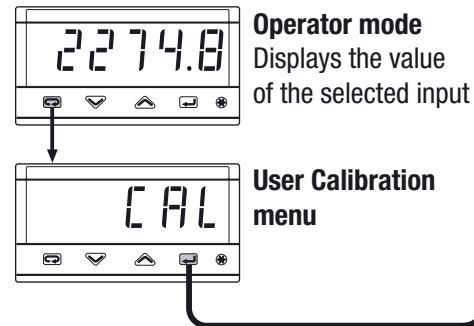

If the value stops changing, the min./max. value has been reached.



4.2.2 MNEMONIC CODES SETTING

(e.g. configuration see page 25)

Press the  or  to display the next or previous mnemonic for the selected parameter.

Continued pressing of  or  will display further mnemonics at a rate faster than one mnemonic every 0.5 s. The mnemonic displayed at the time the next parameter is selected is the one stored in the parameter.

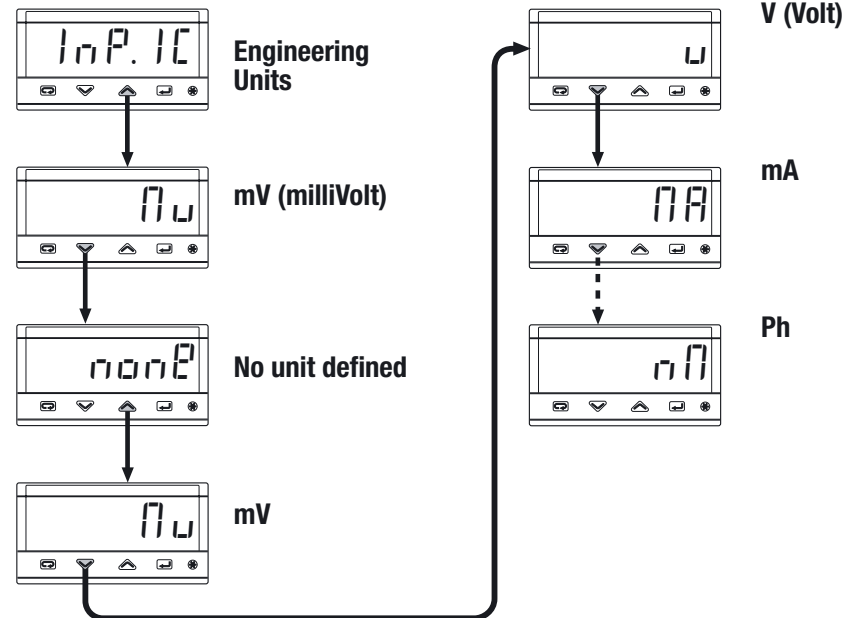

4.3 PARAMETERIZATION - MAIN MENU

This instrument has 3 levels of password protection which allow the administrator to protect access to the various menus.

Once the user selects the desired menu, the indicator prompts for the specific password. When all the passwords are set, *code 1*, configuration (*CONF*) can access all the menus,

code 2, the intermediate one (*Par*) can access the 2 less important menus (*CAL*, *Par*), *code 3*, the third password allows the access only to the calibration menu (*CAL*).

Operator mode

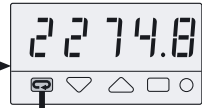

Note:
The password used can be set to a value between 0 and 65535.
Where:
0 menu always accessible
1... 65534 valid Password values
65535 menu always inaccessible (can be set only through the serial communication interface)

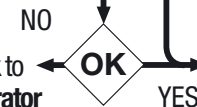
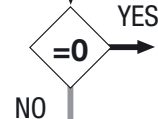

Password 3 Entry

Must be equal to
Code 1 or
Code 2 or
Code 3

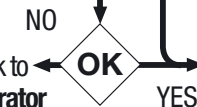
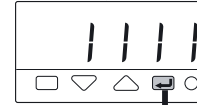
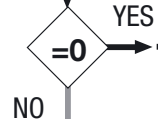

Password 2 Entry

Must be equal to
Code 1 or
Code 2

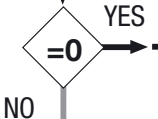

Password 1 Entry

Must be equal to
Code 1

AVAILABLE PARAMETERS

<i>CAL</i>		User calibration menu
<i>Code 3</i>		<i>CAL</i> menu password
<i>tare</i>	<i>curr</i>	Tare current value
	<i>sett</i>	Set tare
	<i>clear</i>	Clear tare value
<i>SCAL</i>	<i>zero</i>	Zero calibration
	<i>hCAL</i>	Span calibration
<i>Exit</i>		Exit <i>CAL</i> menu

<i>Par</i>		Parameter setting menu
<i>Code 2</i>		<i>Par</i> menu password
<i>ALSP</i>	<i>AL□SP</i>	Alarm Setpoint [1]
	<i>ALref</i>	Alarm internal ref. value
<i>ALPar</i>	<i>AL□h</i>	Alarm hysteresis [1]
	<i>AL□d</i>	Alarm activation delay [1]
<i>NEAS</i>	<i>Filter</i>	Filter time constant
	<i>resd</i>	Display resolution
	<i>hold</i>	Hold time
	<i>defsh</i>	Default display parameter
<i>altNEAS</i>		Alternate time
<i>Exit</i>		Exit <i>Par</i> menu

Notes: [1] The parameter must be completed with the alarm number (□ = 1... 4)

[2] The parameter must be completed with the output number (□ = 1... 4)

<i>CONF</i>		Configuration menu	
<i>Code 1</i>		<i>CONF</i> menu password	
<i>BASEC</i>	<i>Conf.1</i>	1 st configuration code	
	<i>Conf.2</i>	2 nd configuration code	
	<i>L.Frq</i>	Power supply frequency	
<i>INP.IC</i>	<i>Unit</i>	IN1 engineering units	
	<i>in.ddd</i>	Number of decimals	
	<i>EFIL1</i>	IN1 filter constant time	
	<i>in.Lo</i>	Low range	
	<i>in.Hi</i>	High range	
	<i>in.ICn</i>	Input conditioning	
	<i>Cut 1</i>	Cut off square root	
	<i>in.1sh</i>	Input shift	
	<i>INP.2C</i>	<i>in.2St</i>	IN2 input type
		<i>in.2dd</i>	Number of decimals
<i>EFIL2</i>		IN2 filter constant time	
<i>in.2Lo</i>		Low range	
<i>in.2Hi</i>		High range	
<i>in.2Cn</i>		Input conditioning	
<i>CIN.C</i>	<i>Cut 2</i>	Cut off square root	
	<i>in.25h</i>	Input shift	
	<i>Cin</i>	Calculate value select	
	<i>Cin.Lo</i>	CIN Input Low Range	
	<i>Cin.Hi</i>	CIN Input High Range	
	<i>Cin.ddd</i>	CIN no. of decimal	

<i>ROUTE</i>	<i>ROSrc</i>	Analog out Source
	<i>ROLYP</i>	Analog Out Type
	<i>ROLo</i>	Analog Out Low Range
	<i>ROHi</i>	Analog Out High Range
<i>DIH</i>	<i>IL1</i>	Digital Input1 Conf
	<i>IL2</i>	Digital Input2 Conf
	<i>IL3</i>	Digital Input 3 Conf
	<i>Prot</i>	Communications protocol
	<i>baud</i>	Baud rate
	<i>Par.Y</i>	Parity
	<i>Addr</i>	Communications Address
<i>CONF</i>	<i>Code 1</i>	Password 1
	<i>Code 2</i>	Password 2
	<i>Code 3</i>	Password 3
	<i>ALNC</i>	<i>AL□Src</i>
<i>AL□OP</i>		Alarm Output [1]
<i>AL□Lb</i>		Latching/blocking [1]
<i>ALNSr</i>		Alarm Ref. Source
<i>CAL</i>	<i>OP□a</i>	Output Action [2]
	<i>ShCAL</i>	Shunt for strain gauge cal.
	<i>CALNd</i>	Calibration Mode
	<i>SCCAL</i>	Enable User cal. menu
	<i>tAREn</i>	Tare menu enable
<i>EDIT</i>	<i>tarePE</i>	Tare value editing enable
	<i>Fact</i>	Instrument calibration
	<i>Exit</i>	Exit <i>CONF</i> menu

4.3.2 PARAMETERIZATION - CALIBRATION MENU

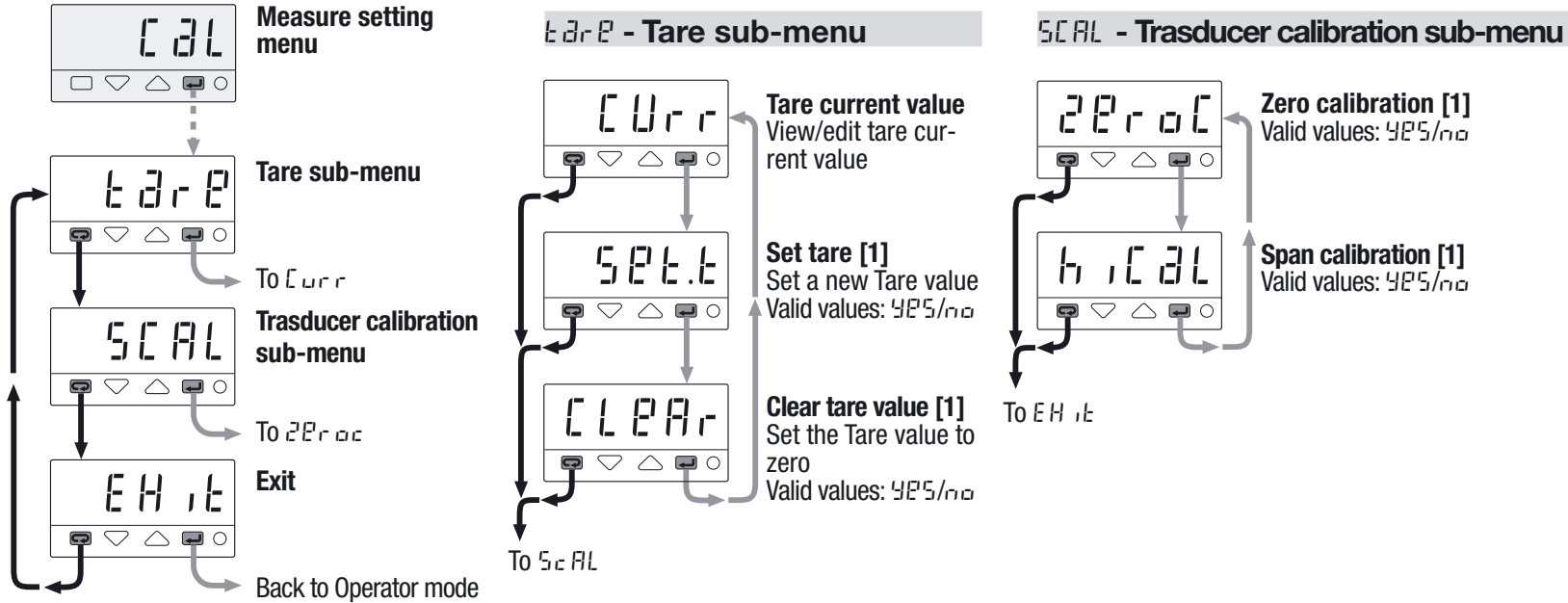

Note:

[1] When the user selects a command scrolling through the list with the  key, to accept the selected command, press the keys

 or  to select:

YES the instrument executes the command as the user presses the  key;

NO the instrument switches to the subsequent command as the user presses the  key

4.3.2 PARAMETERIZATION - PARAMETERS MENU

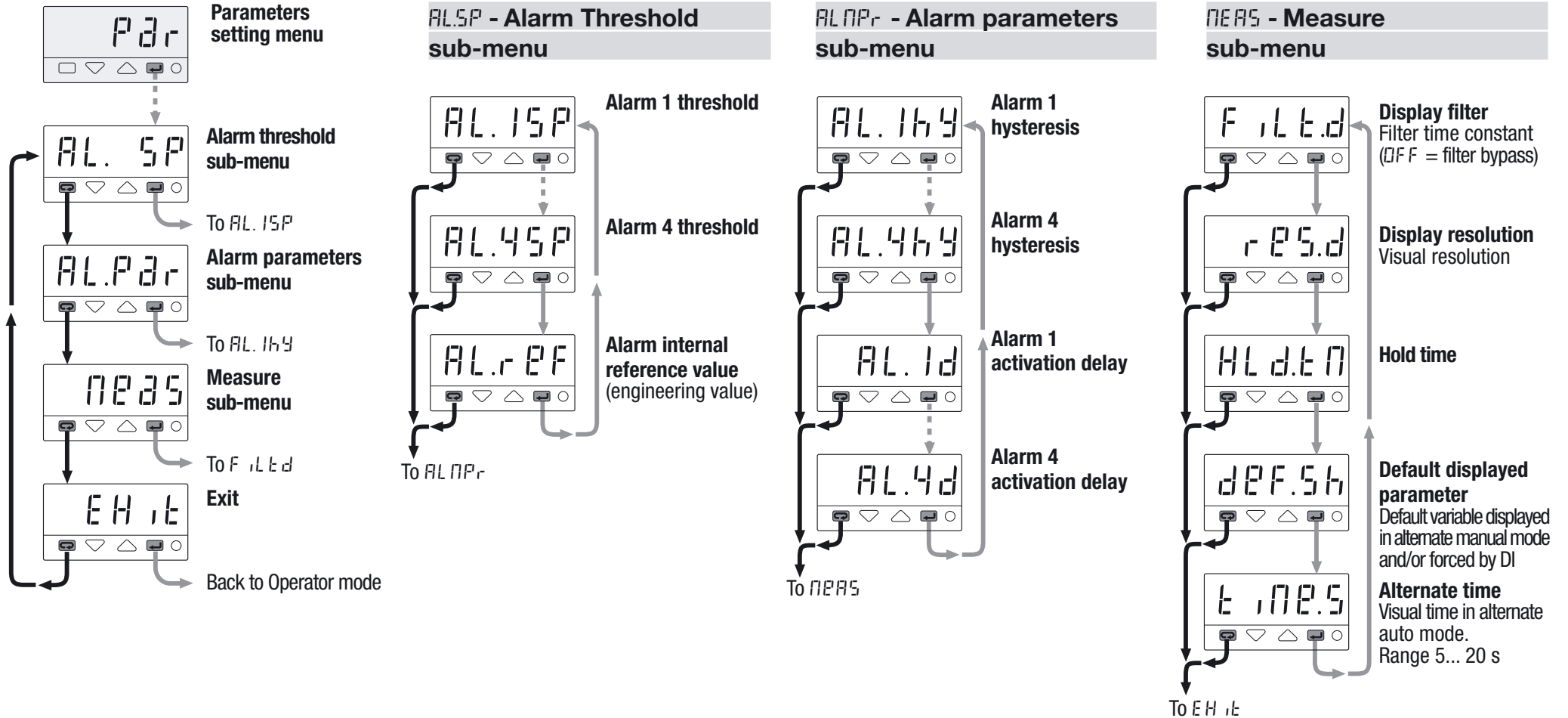

4.3.3 CONFIGURATION MENU

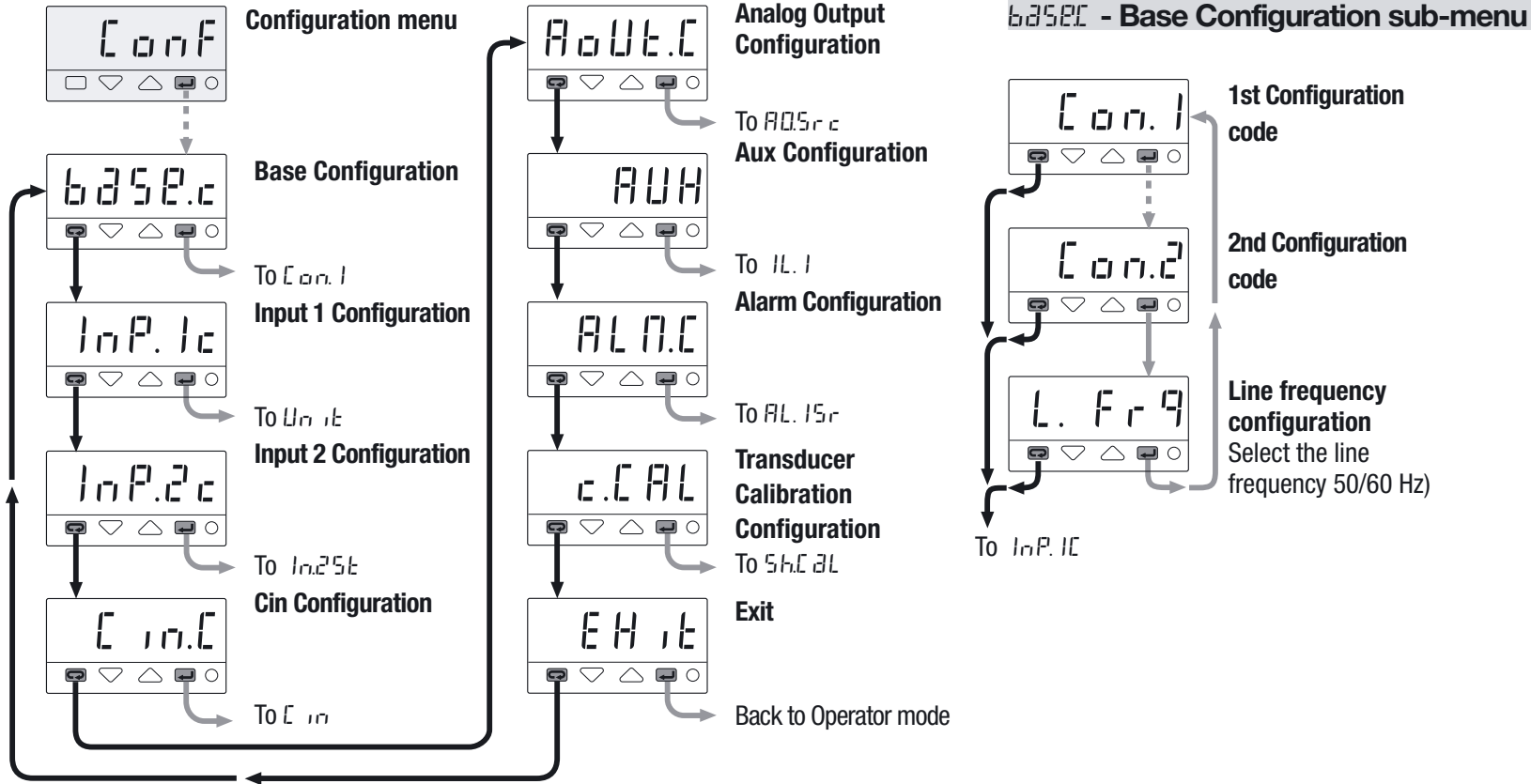

InP.1C - Input 1 Configuration sub-menu

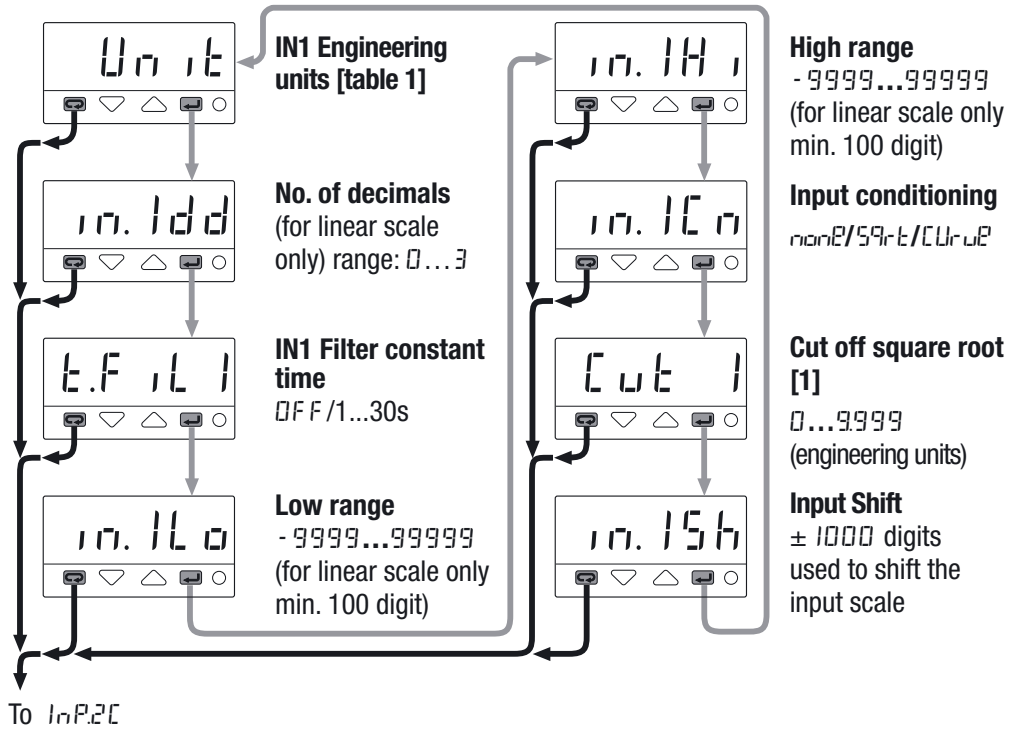

InP.2C - Input 2 Configuration sub-menu

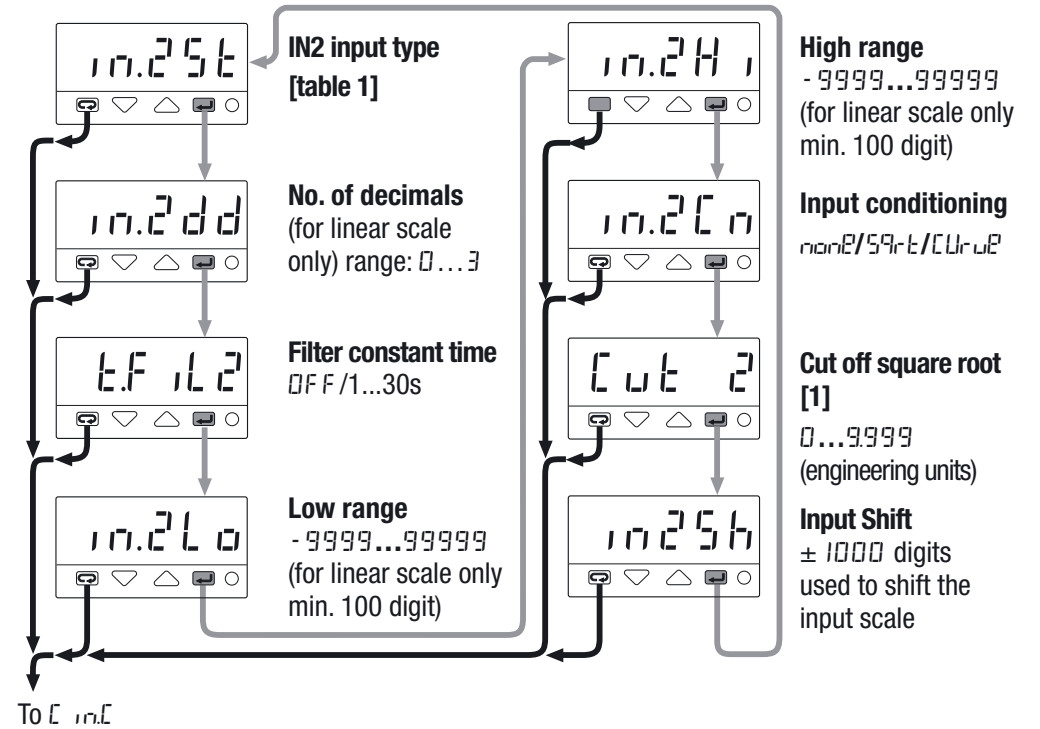

Note:

[1] Cut off the square root of the input value enables the user to round to zero a result that is too low to be important.

Table 1 - Engineering units

Value	Description	Value	Description
°C	Degrees Celsius	g	g (0.001 kg)
°F	Degrees Fahrenheit	kg	kg
none	none	t	t (1000 kg)
mV	mV	q	q (100 kg)
V	Volt	hPa	hPa
mA	mA	MPa	MPa
A	Ampere	mbar	mbar
Bar	Bar	mmH ₂ O	mmH ₂ O
PSI	PSI	mmHg	mmHg
Rh	Rh	kgm	kgm
pH	pH	Nm	Nm

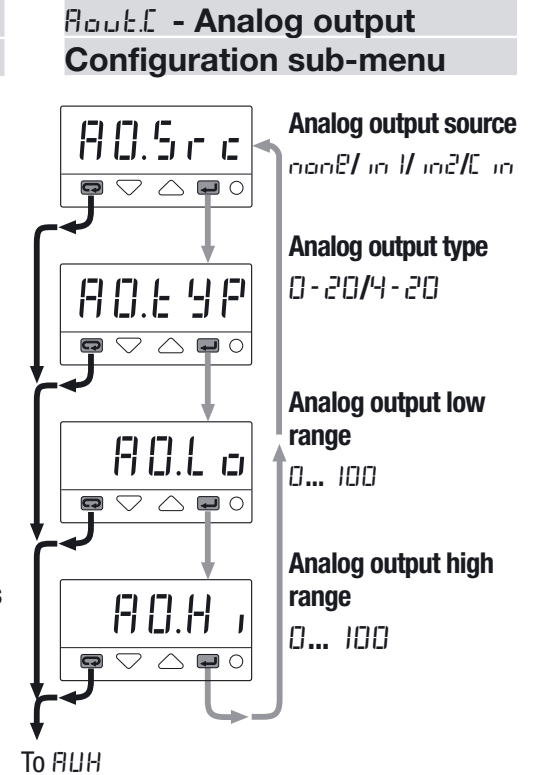
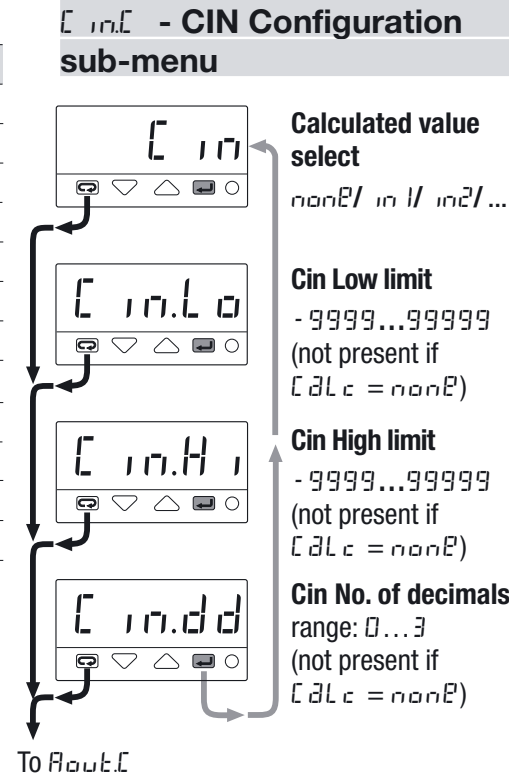

AUX - Auxiliary Parameters Configuration sub-menu

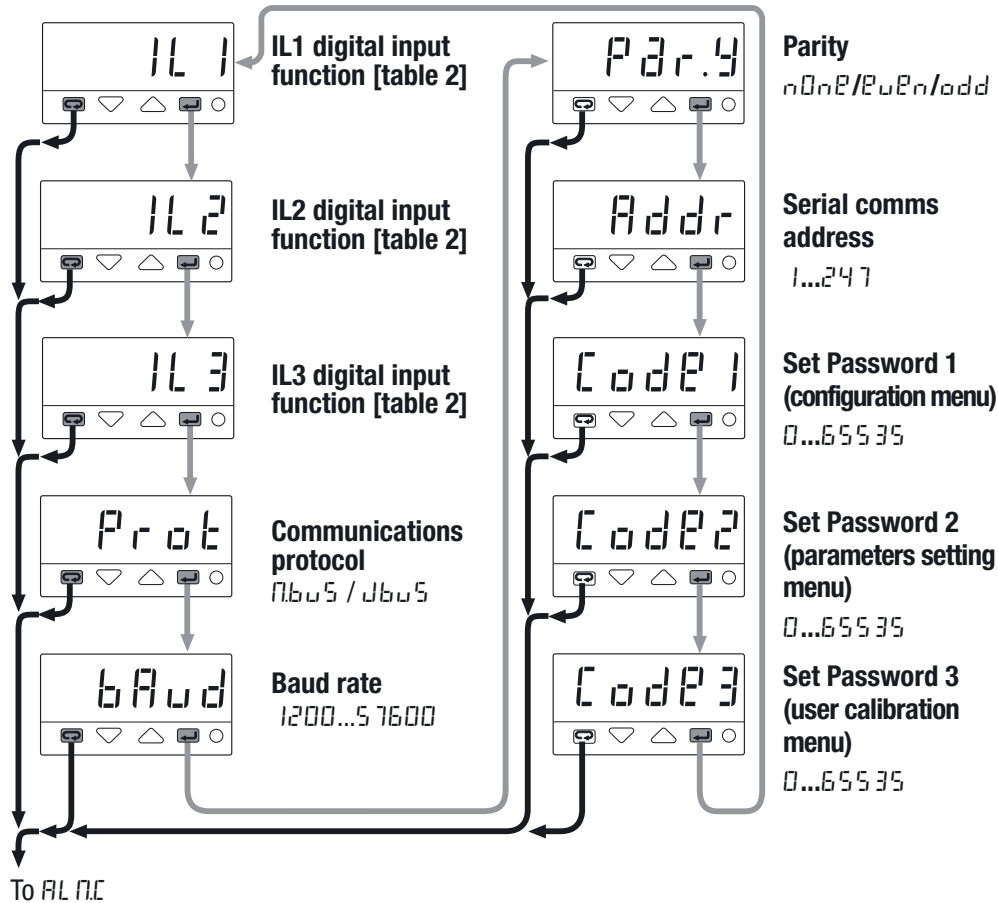

Table 2 - Digital input functions (see also page 38)

	IL 1	IL 2	IL 3
Value	Description		Value
none	Not used		HEPH
EEP1	Keypad lock		HEPL
OPBL	Outputs lock		F.d.S
Act	Alarm acknowledge		SEtE
r.HL	Max. and min. reset		rPSt
HePH	Positive peak enable		ACAL
HePL	Negative peak (valley) enable		SCAL

Additional descriptions for IL 2 and IL 3 values from the table:

- HEPH: Positive peaks sustained display
- HEPL: Negative peaks sustained display
- F.d.S: Display a different parameter
- SEtE: Set tare
- rPSt: Reset tare
- ACAL: Enable strain gauge calibration
- SCAL: Set calibration/Second calibration step (h.CAL)

AL.NC - Alarm configuration sub-menu

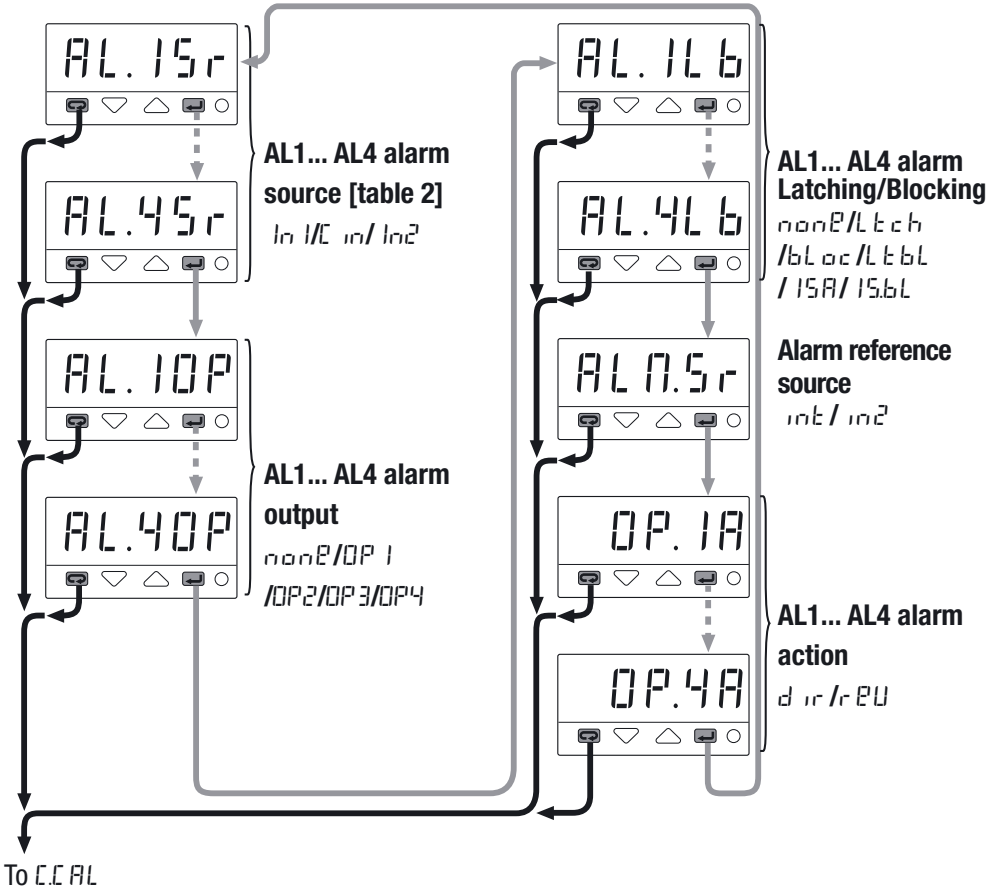

C.CAL - Transducer Calibration sub-menu

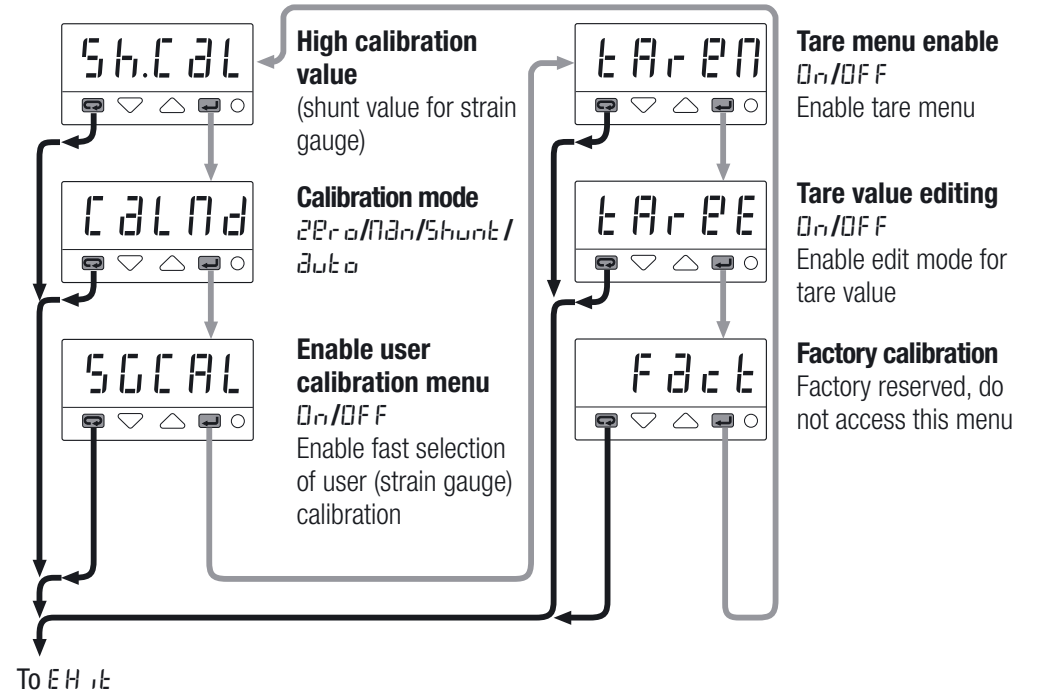

4.4 USER CALIBRATION MENU

To access the sensor calibration and the tare setting functions, the user must access the CAL menu and insert at least the 3rd level password (code 3 at page 39). If one of the passwords is set to zero, access to sensor calibration and tare setting functions is open.

TARE MENU

The TARE menu can be accessed only if the configuration parameter TAREEN is set to $0n$ (page 42); in the tare menu are present the functions:

CURR displays the current tare value or, if the configuration parameter TAREEE is set to $0n$ (page 42); it is possible to modify the tare value manually using the \uparrow and \downarrow (\rightarrow enters the new value).

SETT sets a new tare value. Press the \uparrow / \downarrow keys to select the value YES (enable the tare setting), \rightarrow starts the setting process. During calibration, the instrument displays "r_u_n" and at the end "done".

CLEAR to reset the current tare value. Press the \uparrow / \downarrow keys to select the value YES , \rightarrow clears the tare value.

SCALE MENU

The SCALE menu can be accessed only if the configuration parameter SCALE is set to $0n$ (page 42). Using the functions present in this menu, it is possible to calibrate the sensor on 2 different points: low range (ZEROC) and high range (HIGH). The possible operations in this menu are determined by the configuration parameter CALD (page 42):

$\text{CALD} = \text{AUTO}$: 6 wire strain gauge automatic calibration

When the user sets and confirms the value $0n$ of the parameter ZEROC , the instrument starts the sensor calibration procedure (when the calibration starts, no load must be applied to the sensor). During this process, the instrument calculates and stores the offset from zero, then inserts the shunt resistance (closing OP4 relay), changes the measured value to the HIGH configuration parameter, calculates the span value, stores the calculated value and returns to the normal operation mode.

$\text{CALD} = \text{SHUNT}$: 6 wire strain gauge calibration

This procedure is similar to the previous one except for the fact that, once calibrated at zero, to start the calibration process of the second point the user must select and confirm the value $0n$ for the HIGH parameter.

$\text{CALD} = \text{MAN}$: manual calibration

The operation is similar to the calibration with the shunt, but when activated, the calibration of the second point does not activate OP4 (can be used for different purposes, e.g. as alarm). The two points can be calibrated separately and independently.

$\text{CALD} = \text{ZERO}$: single calibration

This setting allows only the zero calibration procedure (in the menu is present only the parameter ZEROC).

4.4.1 CALIBRATION AND TARE PROCESS

The process that calculates the tare value or the calibration of the strain gauge, performs several functions in order to make the reading more accurate.

If the functions do not pass, the instrument displays an error code that indicates the problem found.

To correctly understand the meaning of the error messages, some aspects of the calibration or the tare setting processes must first be explained.

- For both the processes, the input must be acquired in a known and stable condition to avoid that electrical noise, mechanical disturbances or variations of the input signal can change the quality of the reading. The instrument uses an algorithm that verifies the stability of the input signal and returns an error if it is not stable.
- The strain gauge calibration process defines the zero and a measurement span. On these two measurements a control can be made to avoid that a too small of a span value does not result in a resolution better than or equal to 10 bits.

- Further control is made on the strain gauge calibration in order to verify that the instrument is able to measure the whole range as the calibration process of the high end is made at a value that is 50... 100% of the full range.

Error messages:

Code	Description	Solution
<i>Err 2</i>	Tare not set because the input signal is not stable	Check the cable wiring. Check for noise sources.
<i>Err 3</i>	Strain gauge sensor not correctly connected	
<i>Err 4</i>	Low range calibration command not executed because the input signal is not stable	
<i>Err 5</i>	High range calibration command not executed because the input signal is not stable	
<i>Err 6</i>	Strain gauge calibration span lower than 10 bit resolution	Change the input range
<i>Err 7</i>	The instrument does not cover the whole strain gauge measure range	
<i>Err 8</i>	Low range of strain gauge calibration out of range	



4.5 PARAMETER DESCRIPTION

For ease of operation of the indicator, parameters have been grouped (menu) according to their functional area.

4.5.1 ALARM THRESHOLD SUB-MENU

OP1, OP2, OP3 and OP4 outputs can be used as alarms.

It is possible to configure up to 4 alarms: AL1, AL2, AL3 and AL4 (page 24) selecting for each of them:

- type and operating condition of the alarm (page 34);
- functionality of the alarm acknowledgement (latching)  (page 40);
- start up disabling (blocking)  (page 40);
- Sensor or strain gauge break function (page 34);
- Rate alarm (only for AL1 referred to IN1) (page 34).



AL1 alarm threshold



AL2 alarm threshold







AL3 alarm threshold



AL4 alarm threshold

Parameters to set the threshold of AL1, AL2, AL3 and AL4 alarms.

The range of the alarm threshold corresponds to the whole span.

When an alarm occurs, the display will show the red LEDs , ,  and  respectively ON and, when configured, with a change of the display color, if configured.



Alarms reference value

Internal reference value for deviation and band alarm. Used when $AL.N.Sr = int$ (page 41).

4.5.2 ALARM PARAMETER SUB-MENU



AL1 alarm hysteresis



AL2 alarm hysteresis



AL3 alarm hysteresis



AL4 alarm hysteresis

Hysteresis of the threshold of AL1, AL2, AL3 and AL4 alarms. It is specified as a % of the full range.



AL1 alarm activation delay



AL2 alarm activation delay



AL3 alarm activation delay



AL4 alarm activation delay

Specifies a time (in seconds) that the indicator waits before activating an alarm. Range 0.0...60s in steps of 0.1 s.

4.5.3 MEASURE MANAGEMENT SUB-MENU

The entries present in the menu allow the user to configure:

- Display filter;
- Measure peak hold time;
- Display resolution;
- The default display parameter;
- Alternate display period.

 **Display filter**

This parameter configures the period of time a redout must be sustained before displayed.

Setting range: 1...30.0 s.

Default value: `FFF` (filter bypass).

 **Measure peak hold time**

This parameter allows the configuration of a period of time the peak value will be maintained on the display.

Setting range: 0.5...999.9 s.

 **Display resolution**

This parameter defines the resolution (in digits) that the instrument applies to the display output to make the readout more stable.

Setting range: 1/5/10/20/50/100.

Default value: 5.

 **Default displayed variable**

Defines the name of the variable that is displayed by default when in manual forced display mode (field `M` set to 5) in the configuration code.

Value	Description
<code>In 1</code>	Input 1
<code>In 2</code>	Input 2
<code>[In]</code>	Conditioned input

Default value: In1

 **Alternate display period (Cin active)**

Parameter to set the display time of an alternate measure when the conditioned input is active (`[In]`).

Setting range: 5...60 s.

Default value: 5 s.

4.6 CONFIGURATION MENU

For ease of operation of the indicator, all parameters have been organized in groups (menu), according to their functional area.

4.6.1 BASE CONFIGURATION SUB-MENU

[0 0 1]

1st part of the configuration code

Field [I] allows the selection of the range of the primary input (IN1 page 17); code [L] allows the selection the strain gauge input.

Field [M] allows the selection of the function mode of the display (page 17).

Field [N] selects if and how the peak values are to be held (or not) on the display.

[0 0 2]

2nd part of the configuration code

Fields [O] [P] [Q] and [R] select alarm type and function (page 17).

SENSOR OR STRAIN GAUGE BREAK ALARM FUNCTION

During the configuration phase (page 17) set fields [O], [P], [Q], [R], to value 1. When the PV overcomes the sensor range limits, the sensor break alarm intervention is immediate. **When the alarm condition is no longer present, the alarm stops.**

ABSOLUTE ALARM

During the configuration phase (page 17) set fields [O], [P], [Q], [R], to value 2 (active high) or 3 (active low).

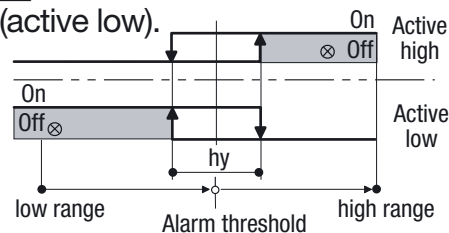

DEVIATION ALARM

During the configuration phase (page 17) set fields [O], [P], [Q], [R], to value 4 (active high) or 5 (active low).

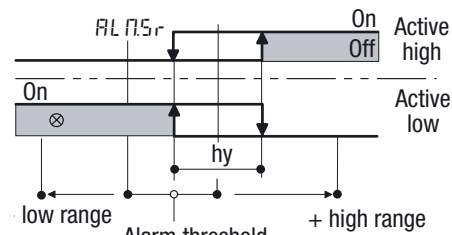

BAND ALARM

During the configuration phase (page 17) set fields [O], [P], [Q], [R], to value 6 (active in) or 7 (active out).

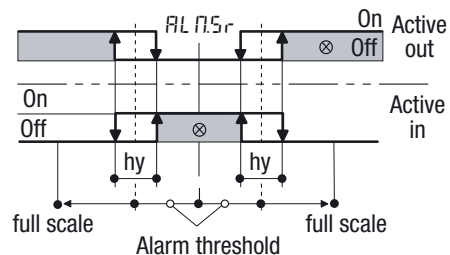

AL1 RATE ALARM FUNCTION

During the configuration phase (page 17) set field [O], to value 8. When the changing rate of the PV connected to the alarm is higher than the specified threshold, AL1 is activated.

Setting range: 0.1... 5.0 digit/s.

For rates between 0.1... 1.0 digit/s, AL1 will be activated after 6...1 s. For rates between 1...5 digit/s, AL1 will be activated after 1s...40ms.

[L F r 9] **Line configuration frequency**

In order to optimize the rejection to line frequency it is necessary to set this parameter to the correct value (50/60 Hz).

4.6.2 IN1 CONFIGURATION SUB-MENU

Engineering units

This parameter sets the desired engineering units. All the engineering units available are listed on page 27, table 1.

IN1 Input number of decimals

This parameter allows the user to set the number of decimals to be displayed for the primary (IN1) input.

For linear scales only.

Setting range: 0...3

IN1 Input 1 filter time constant

Time constant, in seconds, of the RC input filter applied to the PV input.

When this parameter is set to  the filter is bypassed.

Filter response

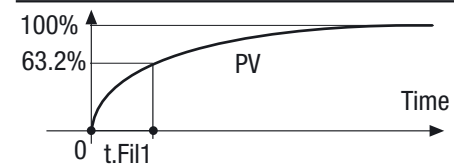

Setting range: 0...30.0 s.

IN1 input low range

IN1 input high range

These parameters allow the user to set the operating range of the primary (IN1) input. For linear scales only.

Setting range: -9999...99999

IN1 measure conditioning

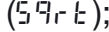
Parameter to enable the conditioning of the IN1 measure. The calculations available are: square root of IN1 measure ();

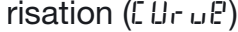
16 segments (or 17 points) linearisation ().

When the value is , no calculation is made on the IN1 measure.

 The 17 points to define the linearisation curve must be entered through the serial communications port; please, read: the “**gam-madue**[®] and **deltadue**[®] series serial communication and configuration software” technical manual for more information.

Cut-off square root result

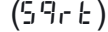
This parameter allows the user to round to zero those results of the square root of IN1 conditioning that are not meaningful (.

Setting range: 0...9999.

Default value: 0.

IN1 input shift

This value is added to the measured IN1 value. Its effect is to shift the whole IN1 scale of up to ± 1000 digits.

Default value: 0.

4.6.3 IN2 CONFIGURATION SUB-MENU

IN2 input type

The parameter defines the range of the secondary input (IN2).

Value	Description
0-5	0...5 V
1-5	1...5 V
0-10	0...10 V
0-20	0...20 mA
4-20	4...20 mA

Number of decimals IN2 input

This parameter allows the user to set the number of decimals to be displayed for the secondary input (IN2).

For linear scales only.

Setting range: 0...3

Input 2 filter time constant

Time constant, in seconds, of the RC input filter applied to the PV input.

When this parameter is set to 0 the filter is bypassed.

Filter response

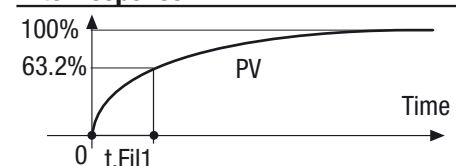

Setting range: 0...30.0 s.

IN2 input low range

IN2 input high range

These parameters allow the user to set the operating range of the primary (IN2) input. For linear scales only.

Setting range: -9999...99999

IN2 measure square root

Parameter to enable the calculation of the square root of IN2 measure (Square = enabled, none = disabled).

Cut-off square root result

This parameter allows the user to round to zero those results of the square root of IN2 conditioning that are not meaningful

Setting range: 0...9999.

Default value: 0.

Secondary input (IN2) shift

This value is added to the measured input 2 value. Its effect is to shift the whole IN2 scale of up to ± 1000 digits.









Default value: 0.

4.6.4 CONDITIONED INPUT CONFIGURATION SUB-MENU

Calculated value selection (Cin)

The Cin parameter selects the type of operation that must be applied to input 1 (IN1) using the secondary input (IN2); the result is the conditioned input (.

In the table that follows are listed the possible conditioning operations:

Id	Description
	Cin = IN1
	Cin = IN2
	Cin = IN1 + IN2
	Cin = IN1 - IN2
	Cin = (IN1 + IN2)/2
	Cin = MAX (IN1, IN2)
	Cin = Min (IN1, IN2)
	Cin = IN1 * IN2
	Cin = IN1/IN2

Low range for conditioned value

High range for conditioned value

These parameters define the range for the conditioned measure (.

Number of decimals for Cin value

This parameter allows the user to set the number of decimal digits to be displayed for the primary (IN1) input.

Setting range: 0...3

4.6.5 ANALOG OUTPUT CONFIGURATION SUB-MENU

Analog output source

Selects the variable to be put on the analog output.

Setting values: None, In1, Cin, In2.

Analog output type

Selects the type of signal retransmitted by the analog output.

Values: 0... 20 mA, 4... 20 mA.

Default value: 0...20mA.

Analog output low range

Analog output high range

Range of the analog output:

AOLo: -9999...99999

AOHi: -9999...99999

Default values:

AOLo: 0

AOHi: 10000

4.6.6 AUXILIARY PARAMETER CONFIGURATION SUB-MENU

IL1 digital input function

IL2 digital input function

















IL3 digital input function

A function is assigned through the configuration procedure to each IL1, IL2 and IL3 digital input (see the parameters setting at table 2 at page 28).

The configured function is activated when the digital input (free voltage contact or open collector output) is in the ON state (closed). It is deactivated by setting the input to the OFF state (open).

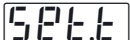
The activation of the function through the digital input has the highest priority than through the keypad or through the serial communications.

4 - Operations

Function	Parameter Value	Performed operation		Notes
		 Off	 On	
None		—	—	Not used
Keypad lock		Unlocked	Locked	With the keypad locked the commands from digital inputs and serial communications are still operating
Outputs lock		Normal operation	Outputs lock	Closing the contact causes the setting to the logical status 0 of the output ports. The retransmission analog output is forced to the low limit (0 or 4 mA)
Alarm acknowledge		Normal operation	Alarm acknowledge	Closing the contact causes the acknowledgement of the active alarms
Peak and Valley value reset		Normal operation	Reset Peak and Valley	Closing the contact causes the reset of the stored maximum and minimum value
Measure hold		Normal operation	Measure hold locked	Closing the contact locks the measurement of the IN1 input. In accordance, all the values directly connected to IN1 measure are locked.
Positive peak hold enable (peak)		Normal operation	Shows the max. value read	The display shows the maximum value read all the time the contact is closed. The number displayed changes in case of higher max. values
Negative peak hold enable (valley)		Normal operation	Shows the min. value read	The display shows the minimum value read all the time the contact is closed. The number displayed changes in case of lower min. values
Positive peaks sustained display		Normal operation	Max. value + normal operation	The display shows, for a programmable period of time (<i>HL dE Π</i>), the max. value read, then returns to normal operation
Negative peaks sustained display		Normal operation	Min. value + normal operation	The display shows, for a programmable period of time (<i>HL dE Π</i>), the min. value read, then returns to normal operation
Display a different parameter		Normal operation	Alternate display	For all the period the contact is closed the display shows the value of the variable set with the <i>dPESh</i> parameter
Set Tare		Normal operation	Set the new tare value	Closing the contact causes the storing of the PV as tare value
Reset Tare		Normal operation	Reset the tare value	Closing the contact causes the reset of the stored tare value
Enable automatic calibration		Normal operation	Enable calibration	Closing the contact enable the automatic calibration process of the strain gauge (see page 30)
Start automatic calibration		Normal operation	Start calibration	Closing the contact causes the starting of the automatic strain gauge calibration

SERIAL COMMUNICATION PARAMETERS (OPTIONAL)

The parameters that follow are displayed only when the optional RS485 serial communications is installed in the instrument.

 **Communications protocol**

 **Baud rate**

 **Parity**

 **Instrument serial address**

Setting values:

Protocol: Modbus/Jbus.

Baud rate: 200/2400/4800/9600/
19200/38400/
57600 baud.

Parity: none/Even/odd.

Instrument serial address: 1...247

Default values:

Protocol: Jbus.

Baud rate: 9600 baud.

Instrument serial address: 1

Parity: none.

SAFETY PARAMETERS

 **Set Cal menu access code (1)**

 **Set Par menu access code (2)**

 **Set Conf menu access code (3)**

These parameters allow the user to change the factory default passwords.

When one code is set to zero, access to the menu(s) connected to that code is (are) accessible (see page 21). When, using the serial communications port, and the user sets a code to 65535, the menu(s) connected to that code is (are) locked.

Setting ranges: 0...65534 (the value 65535 can be set only from the serial communications port)

Default values:

Code1: 3333

Code2: 1111

Code3: 1234

4.6.7 ALARM PARAMETERS CONFIGURATION SUB-MENU

The entries of this menu allow the user to configure the functioning parameters of alarms AL1, AL2, AL3 and AL4.

 **AL1 alarm source**

 **AL2 alarm source**

 **AL3 alarm source**

 **AL4 alarm source**

Sets, for each alarm, the signal source to be considered.

Setting values: IN1, Cin; IN2.

Default value: IN1

 **AL1 alarm output**

 **AL2 alarm output**

 **AL3 alarm output**

 **AL4 alarm output**

These parameters connect each alarm to the output port to be activated when an alarm condition occurs.

Setting values:

none, OP1, OP2, OP3, OP4

Default values: **AL1:** OP1

AL2: OP2,

AL3: none

AL4: none.

AL.1Lb

**AL1, AL2, AL3,
AL4 latching
and blocking
function**

AL.2Lb

AL.3Lb

AL.4Lb

For each alarm, it is possible to select one of the following functions:

none none;

latch acknowledge;

block blocking;

latch latching + blocking

ISA ISA ack. sequence

ISA.bL ISA ack. sequence +
blocking

latch

ALARM

ACKNOWLEDGE FUNCTION

Once an alarm occurs it is indicated on the display until it is acknowledged. To acknowledge an alarm press the \ast key. **After this operation, the alarm changes state only when the alarm condition is no longer present.**

block

START-UP DISABLING

Ramp down

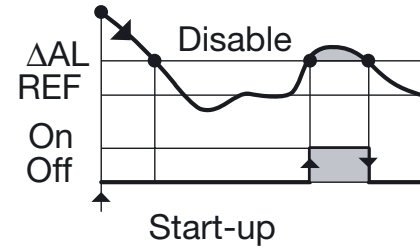

Ramp up

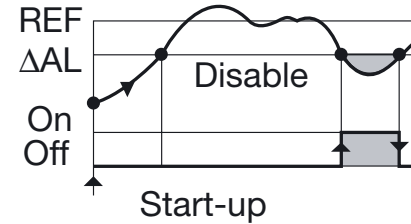

ΔAL Threshold = REF \pm range

15A

“ISA A” ALARM RESET SEQUENCE

The alarm intervention activates both the visual alarm (the alarm LED on the display) and the audible alarm (the OP output used to activate for example a buzzer or a siren). When the operator acknowledges the alarm, the status of the two alarms differ if the alarm condition has been removed or not. In the table that follows, the visual and audible alarm status are pointed out for each condition.

Status	Status changes				Visual alarm (alarm LED)	Audible alarm (OP output)
	Input variable		Reset (ACK)			
	Normal condition	Alarm condition	Reset not done	Reset done		
No alarm active	No status changes	Go to status: Alarm not acknowledged			OFF	OFF
Alarm not acknowledged			No status changes	Go to status: Acknowledged alarm	Flashing	Active
Acknowledged alarm	Go to status: No alarm active	No status changes			Steady ON	OFF

AL.N.S.r

Alarm reference source

This parameter allows the user to select the reference value to be used for the alarms.

Values: Int/In2/Cin

Default: Int (the value set in *AL.r EF* page 32).

OP.1a

Output OP1 action

OP.2a

Output OP2 action

OP.3a

Output OP3 action

OP.4a

Output OP4 action

Sets the type of action of the output port.

Values: **direct** (relay-coil activated in alarm condition), **reverse** (relay-coil not activated when in alarm condition).

Default value: direct.

4.6.8 TRANSDUCER CALIBRATION SUB-MENU

The `CCAL` menu allows the user to choose the transducer calibration mode.

`Sh.CAL` Shunt for strain gauge calibration

This parameter sets the value, in percentage, of the higher calibration point of the strain gauge (the shunt value).

Setting range: 50...100%

Default value: 80% (standard value of the 6 wire strain gauge shunt).

`CALNd` Transducer calibration mode

This entry selects the type of calibration procedure to be performed.

Setting values: `ZERO`, `MAN`, `SHUNT`, `AUTO`

`ZERO` Enables only the zero calibration

`MAN` Both the Zero and Span are enabled. The calibration processes are started through separate operator commands. OP4 output is not associated to the span calibration phase.

`SHUNT` Both the Zero and Span are enabled. The calibration processes are started through separate operator commands. OP4 relay is associated to the Span calibration phase and is activated automatically in order to insert the shunt of the 6 wire strain gauge.

`AUTO` Both the Zero and Span are enabled. The calibration processes are started through an operator command. OP4 relay is activated automatically in order to insert the shunt of the 6 wire strain gauge.

`SCAL` Enable sensor calibration

`ETAREN` Enable set tare command

Enable/Disable access to the transducer calibration sub-menu (page 23) and to `ETARE` sub-menu (page 23). When both are disabled, the `SCAL` menu is hidden.

Setting values: ON/OFF

Default value: ON.

`ETARE` Enable edit tare

Enable/Disable the editing of the tare value with the `CURR` command (page 30).

Setting values: ON/OFF

Default value: ON.

`Fact` Factory calibration

 The instrument calibration is a factory procedure. It can be performed by the end user with caution. The menu is protected with a password.

5

DISPLAYS

5.1 DISPLAYING THE PROCESS VARIABLES [1]

Operator mode

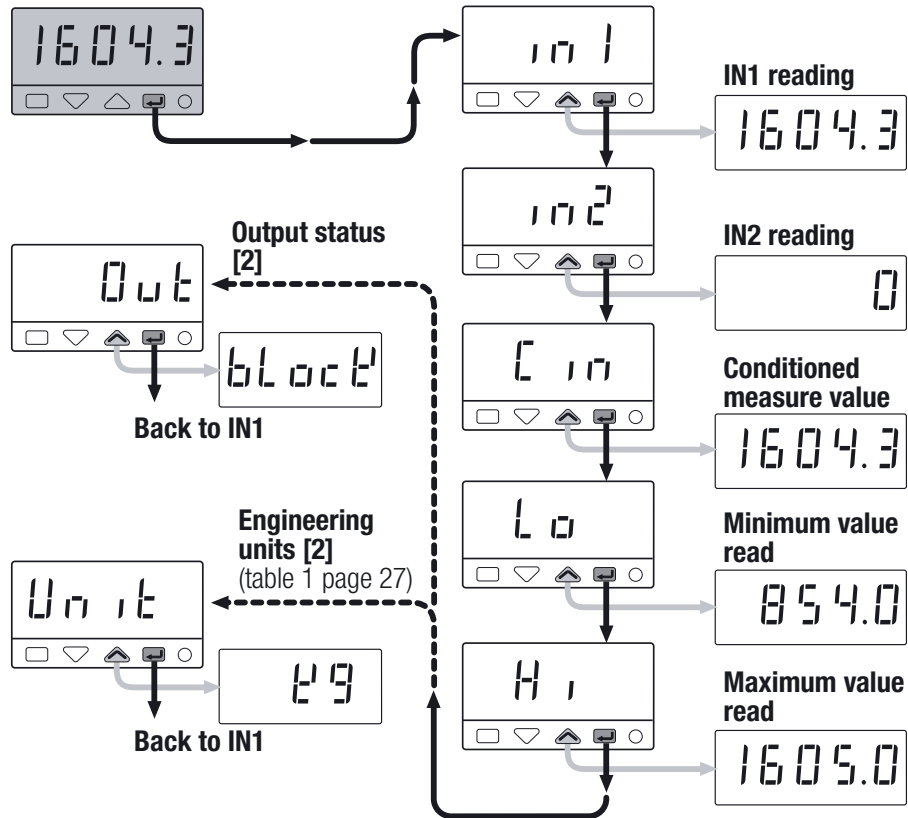

5.2 DISPLAYING THE CONFIGURATION CODES [1]

Operator mode

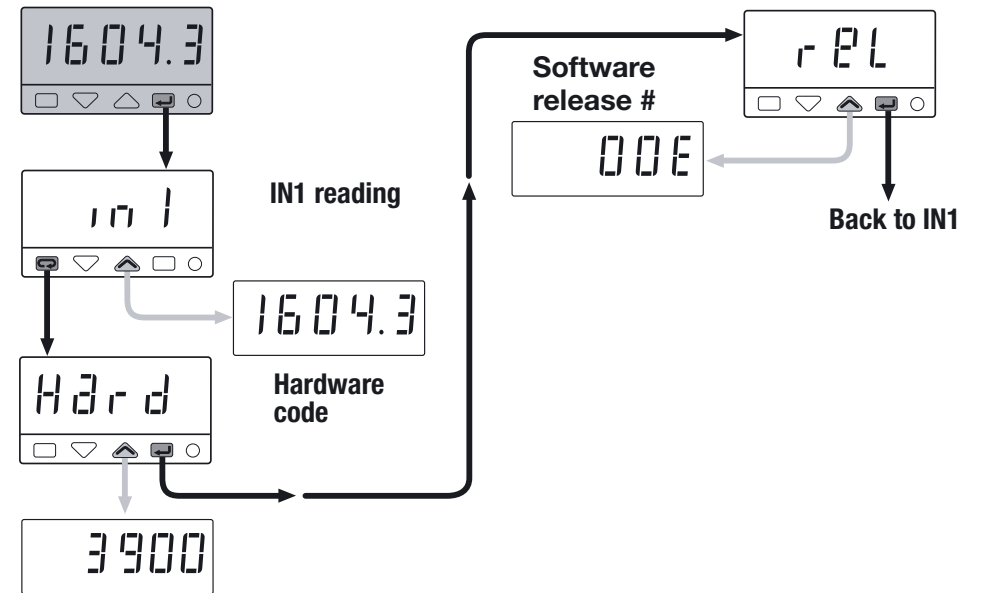
**Notes:**

- [1] To exit the Display functions and return to the Operator mode, wait 5 seconds without touching the instrument buttons.
- [2] *block* is displayed when the outputg are locked (page 45), *Unit* is displayed when the outputs are unlocked.

COMMANDS

COMMANDS TO THE INDICATOR AND OPERATING PROCEDURE

The commands can be entered in 3 ways:



6.1 KEYPAD

see page 45

- Keypad lock
- Outputs lock

6.2 DIGITAL INPUTS

see page 32

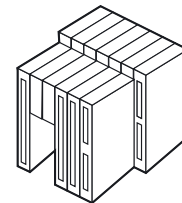



6.3 SERIAL COMMUNICATIONS

see the manual on this topic



6.1 KEYPAD COMMANDS

6.1.1 KEYPAD LOCK/UNLOCK

To lock/unlock the keypad, press and hold the keys  and  simultaneously for 2 seconds. With keypad locked, if the user presses a key, the instrument displays the message “L o c k”.

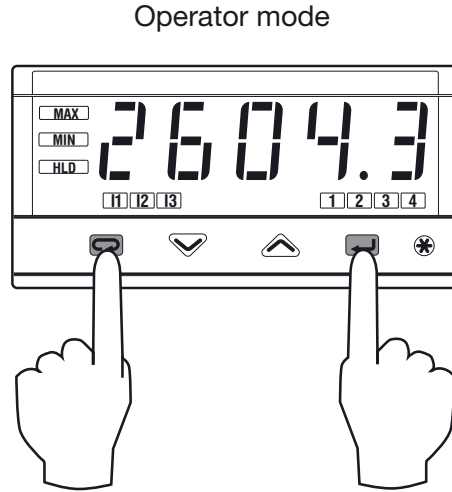

The keypad lock/unlock can also be achieved over serial communications.

 The keypad lock is retained in the event of power failure.



Press simultaneously
for 2 seconds

6.1.2 OUTPUT LOCK/UNLOCK

The outputs are switched to the OFF status by pressing and holding the keys  and  simultaneously for 2 seconds. With the outputs locked, when displaying the process variables the instrument displays the message “b l o c k” instead of “U n l o c k”.

To unlock the outputs press the keys simultaneously again.

The outputs lock/unlock can also be achieved over serial communications.

 The outputs lock is retained in the event of power failure.

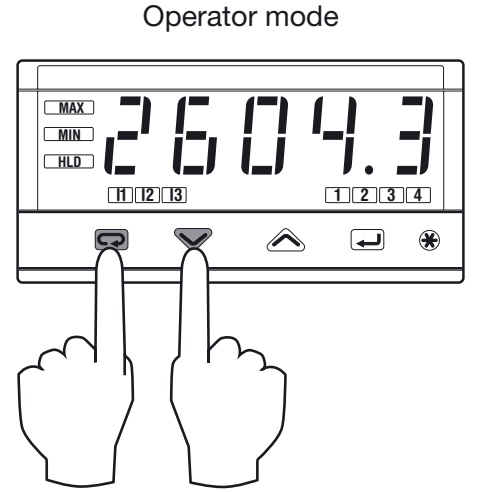

Press simultaneously
for 2 seconds

7 TECHNICAL SPECIFICATIONS

Features (at 25°C env. temperature)	Description			
Dual color display	5 digit, high efficiency, height 15 mm, limits: -9999...99999 red or green configurable depending on the user needs and/or the alarm status			
IN1 Main input (see pages 11,12 and 16)	Common characteristics	A/D converter with 16 bit resolution Overall response time: 20 ms Input shift: ± 1000 digit Input filter: 1...30 s (OFF= 0)		
	Accuracy	0.1% ± 1 digit; between 85...240 Vac the error is negligible		
	Strain gauge bridge excitation	5V/10V selectable	350 Ω ...10k Ω bridge load	
	DC input Current	0/4...20 mA	Engineering units, Floating decimal point, Display resolution: 1, 2, 5, 10, 50, 100 digits selectable	Accuracy 0.1% Sampling rate 20 ms Input drift: <0.1%/20°C ambient temperature
IN2 second input (option)	DC Current	0/4... 20 mA R input = 60 Ω		
	DC Voltage	1/0...5, 0...10 V		
Digital inputs (3 logic not isolated from internal electronics)	The voltage free contact closure enables:	Keyboard lock, Output block, Alarm acknowledge, Min./Max. reset, Measure hold, Peak or Valley hold, Display variable select, Strain gauge calibration, Tare set		

Features (at 25°C env. temperature)	Description			
OP1 output	SPDT relay, 2A/250Vac (4A/120Vac) for resistive load			
OP2 output (opt.)	SPST relay N.O., 2A/250Vac (4A/120Vac) for resistive load			
OP3 output (opt.)	SPST relay N.O., 2A/250Vac (4A/120Vac) for resistive load			
OP4 output	SPST relay N.O., 2A/250Vac (4A/120Vac) for resistive load			
OP5 analog output (option)	0/4...20mA, 750Ω/15V max. To retransmit: IN1, IN2 or CIN Accuracy: 0.1% Resolution: 12 bit Galvanic isolation: 500Vac/1min			
AL1 - AL2 - AL3 - AL4	Hysteresis 0.1...10.0%			
	Active high Active low	Action type	Changing rate threshold	0.1...5.0 digit/s
			Deviation threshold	± range
			Band threshold	0...range
			Absolute threshold	whole range
Action	Special functions	Strain gauge break, Sensor break, Acknowledge (latching), Activation inhibit (blocking), OR'ed of different sources of alarms, ISA-A acknowledge sequence for activation of visual and audible alarm		

7 - Technical specification

Features (at 25°C env. temperature)	Description	
Serial comms. (optional)	RS485 isolated, Modbus/Jbus protocol, 1200, 2400, 4800, 9600, 19200, 36400, 56800 bit/s, 3 wire	
Auxiliary power supply	+24Vdc \pm 20%, 30 mA max. for a 4... 20 mA, 2 wire transmitter	
Operational safety	Input measure	Detection of out of range, short circuit or sensor break with automatic activation of the safety strategy and alerts on display
	Parameters	A non volatile memory stores for unlimited time all the configuration and parameter values
	Access protection	3 password levels to access the strain gauge calibration, Configuration and Parameters data, Keyboard lock, Outputs Block
General characteristics	Power supply	100...240Vac (-15...+10%) 50/60Hz or 24Vac (-25...+12%) 50/60Hz and 24Vdc (-15...+25%) Power consumption 4W max. (PTC protected)
	Safety	Compliance EN61010-1 (IEC 1010-1), installation class 2 (2.5kV) pollution class 2, class II instrument
	Electromagnetic compatibility	Compliance to the CE standards for industrial systems and equipment
	UL & cUL approval	File E176452 (pending)
	Protection EN60529 (IEC529)	IP65 front panel
	Dimensions	1/8 DIN - 96 x 48, depth 110 mm, weight 250g approx.























WARRANTY











We warrant that the products will be free from defects in material and workmanship for 3 years from the date of delivery.











The warranty above shall not apply for any failure caused by the use of the product other than as instructed in this manual.

ICON TABLE

Main universal input	
	Strain gauge input
	Custom
	Linearize Custom input
	mA and mV
	Thermocouple
	RTD (Pt100)
	Frequency
	Delta Temp (2x RTD)

Special Functions	
	Display the minimum stored value
	Display the maximum stored value
	Hold peaks or valleys
	Hold the PV
	Conditioned Input
	NO/NC Alarm status
	Keypad lock
	Outputs lock
Auxiliary input	
	Current transformer
	mA Remote setpoint
	Volt Remote setpoint
	Feedback potentiometer

Digital input	
	Isolated contact
	NPN open collector
	TTL open collector
Setpoint	
	Local
	Stand-by
	Start-up function
	Timer function
	Memorized
	Remote
	Setpoint programmer

Digital input connected functions	
	Auto/Manual
	Run, Hold, Reset and program selection
	PV hold
	Setpoint slopes inhibition
Output	
	SPST Relay
	Triac
	SPDT Relay
	mA
	mA mV
	Logic

ASCON WORLDWIDE SALES NETWORKS

SUBSIDIARY

FRANCE

ASCON FRANCE

2 bis, Rue Paul Henri Spaak
ST. THIBAUT DES VIGNES
F-77462 LAGNY SUR MARNE - Cedex
Tél. +33 (0) 1 64 30 62 62
Fax +33 (0) 1 64 30 84 98
ascon.france@ascon.fr

AGENCE SUD-EST

Tél. +33 (0) 4 74 27 82 81
Fax +33 (0) 4 74 27 81 71

USA

ASCON CORPORATION

1884 East Fabyan Parkway
Batavia, Illinois 60510
Tel. +1 630 482 2950
Fax +1 630 482 2956
www.asconcorp.com
info@asconcorp.com

DISTRIBUTORS

ARGENTINA

MEDITECNA S.R.L.

Phone +5411 4585 7005
Fax +5411 4585 3434

AUSTRALIA

ONETEMP PTY - IPA INDUSTRIAL

PYROMETER (AUST) PTY.LTD

Phone +61 8 8352 3688
Fax +61 8 8352 2873

FINLAND & ESTONIA

TIM-TOOL OY

Phone +358 50 501 2000
Fax +358 9 50 55 144

GERMANY

MESA INDUSTRIE ELEKTRONIK GMBH

Phone +49 2365 915 220
Fax +49 2365 915 225

GREECE

CONTROL SYSTEM

Phone +30 31 521 055-6
Fax +30 31 515 495

BRANCH OFFICE

Phone +30 1 646 6276
Fax +30 1 646 6862

HOLLAND

TEMPCONTROL IEP B.V.

Phone +31 70 3476431
Fax +31 70 3825516

POLAND

ASCON POLSKA Sp. z o.o.

Phone +48 34 35 33 619
Fax +48 34 35 33 884

PORTUGAL

REGIQUIPAMENTOS LDA

Phone +351 21 989 0738
Fax +351 21 989 0739

SPAIN

INTERBIL S.L.

Phone +34 94 453 50 78
Fax +34 94 453 51 45

BRANCH OFFICE

Phone +34 93 311 98 11
Fax +34 93 311 93 65
Phone +34 91 656 04 71
Fax +34 91 677 21 26

SWITZERLAND

CONTROLTHERM GMBH

Phone +41 1 954 37 77
Fax +41 1 954 37 78

TURKEY

KONTROL SISTEMLERI LTD

Phone +90 216 302 19 70-71
Fax +90 216 302 19 72

UNITED KINGDOM

EUKERO CONTROLS LTD

Phone +44 20 8568 4664
Fax +44 20 8568 4115

