

ASCON spa

ISO 9001
Certified

ASCON spa
via Falzarego, 9/11
20021 Bollate
(Milano) Italy
Tel. +39 02 333 371
Fax +39 02 350 4243
<http://www.ascon.it>
e-mail support@ascon.it

**Double input indicator
with analogue output**
1/8 DIN - 96 x 48



J3 line

User Manual • M.I.U.J3 - 1/05.02 • Cod. J30-478-1AJ3 IE



**Double input indicator
with analogue output
1/8 DIN - 96 x 48**

J3 line

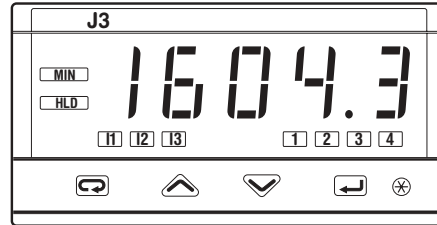



NOTES

ON ELECTRIC SAFETY AND ELECTROMAGNETIC COMPATIBILITY

Please, read these instructions carefully before proceeding with the installation of the controller.

Class II instrument, rear panel mounting.

This indicator has been designed in compliance with:

Regulations on electrical apparatus (appliance, systems and installations) according to the European Community directive 73/23/EEC amended by the European Community directive 93/68/EEC and the Regulations on the essential protection requirements in electrical apparatus EN61010-1 : 93 + A2:95.

Regulations on Electromagnetic Compatibility according to the European Community directive #89/336/EEC, amended by the European Community directive #92/31/EEC, 93/68/EEC, 98/13/EEC and the following regulations:

Regulations on RF emissions

EN61000-6-3 : 2001 residential environments

EN61000-6-4 : 2001 industrial environments

Regulation on RF immunity

EN61000-6-2 : 2001 industrial equipment and system

It is important to understand that it's the responsibility of the installer to ensure compliance with the regulations on safety requirements and EMC.

The device has no user serviceable parts and requires special equipment and specialised engineers. Therefore, a repair cannot be carried out directly by the user. For service or repair, contact the manufacturer or your sales representative.

All the information and warnings about safety and electromagnetic compatibility are marked with the  sign, at the side of the note.

TABLE OF CONTENTS



1	INSTALLATION	Page	4
2	ELECTRICAL CONNECTIONS	Page	8
3	PRODUCT CODING	Page	14
4	OPERATIONS	Page	18
5	DISPLAYS	Page	34
6	COMMANDS	Page	35
7	TECHNICAL SPECIFICATIONS	Page	37

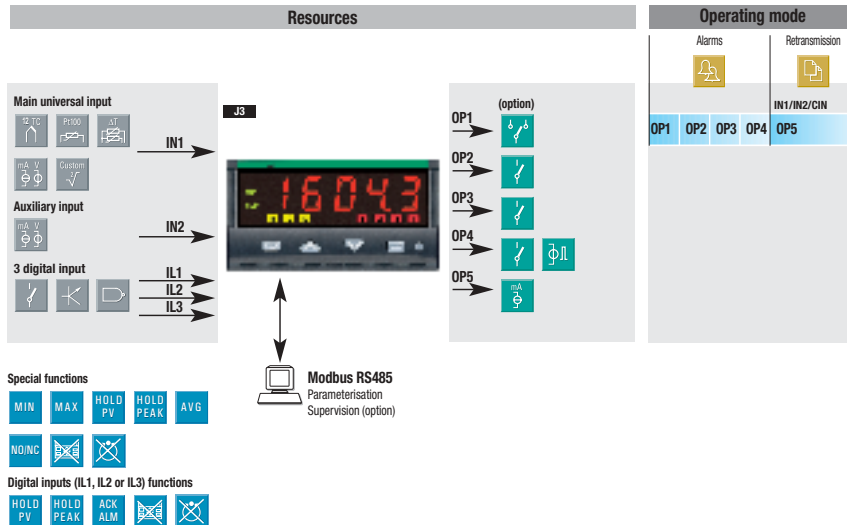

INSTALLATION

Installation must only be carried out by qualified personnel.

Before proceeding with the installation of this indicator follow the instructions illustrated in this manual with particular attention to the installation precautions marked with the  symbol, related to the European Community directive on electrical protection and electromagnetic compatibility.



To prevent hands or metal touching parts that may be electrically live, **the indicators must be installed in an enclosure.**

1.1 GENERAL DESCRIPTION

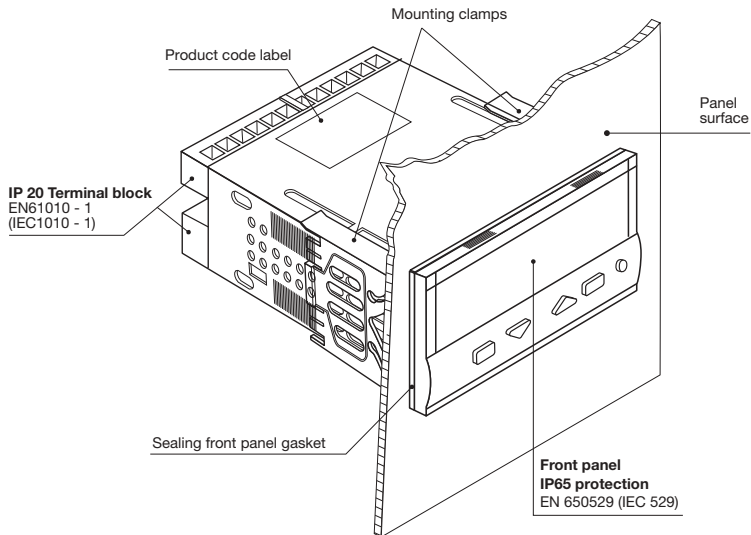

1.2 DIMENSIONAL DETAILS

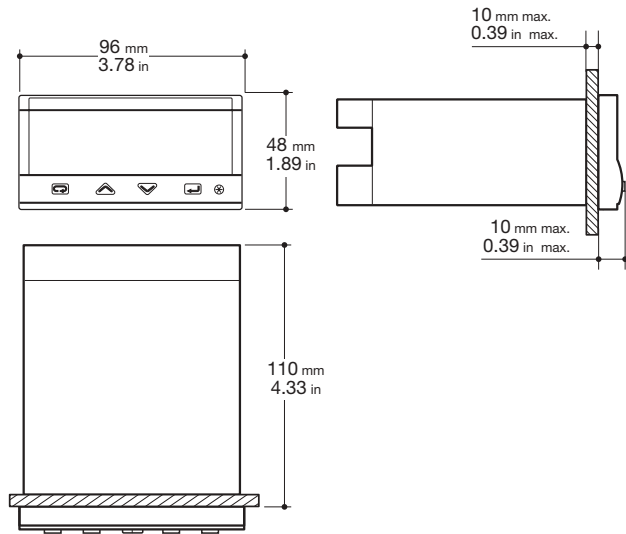

1.3 PANEL CUT-OUT

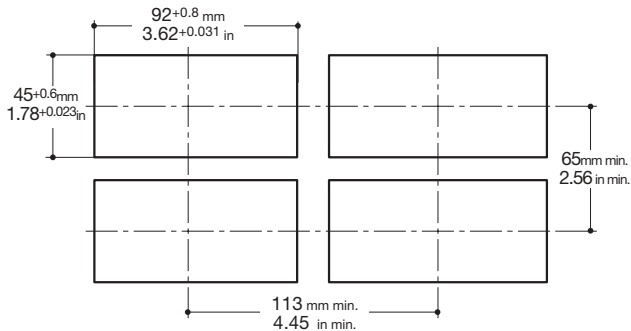

1.4 ENVIRONMENTAL CONDITIONS



Operating conditions



Altitude up to 2000 m



Temperature 0...50°C

%Rh

Relative humidity 5...95 % non-condensing

Special conditions
Suggestions

Altitude > 2000 m

Use 24Vac supply version



Temperature >50°C

Use forced air ventilation

%Rh

Humidity > 95 %

Warm up



Conducting atmosphere

Use filter

Forbidden Conditions

Corrosive atmosphere



Explosive atmosphere

1.5 PANEL MOUNTING [1]

1.5.1 INSERT THE INSTRUMENT

- 1 Prepare panel cut-out
- 2 Check-front panel gasket position
- 3 Insert the instrument through the cut-out

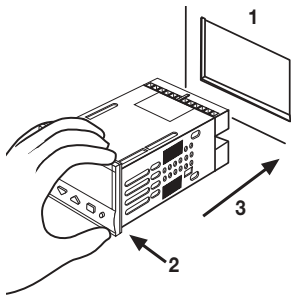

UL note
[1] For Use on a Flat Surface of a Type 2 and Type 3 'raintight' Enclosure.

1.5.2 INSTALLATION SECURING

- 1 Fit the mounting clamps as shown
- 2 Push the mounting clamps toward the panel surface to secure the instrument

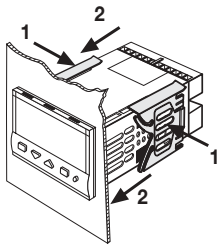

1.5.3 CLAMPS REMOVING

- 1 Insert the screwdriver in the clips of the clamps
- 2 Rotate the screwdriver

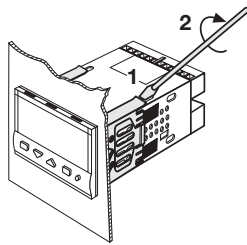

1.5.4 INSTRUMENT UNPLUGGING



- 1 Push and
- 2 Pull forward to remove the instrument

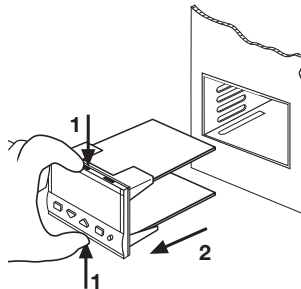

Electrostatic discharges can damage the instrument. Before removing the instrument the operator must discharge himself to ground.



2 ELECTRICAL CONNECTIONS

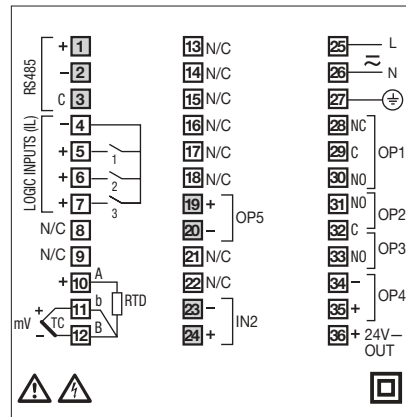

UL note

[1] Use 60/70 °C copper (Cu) conductor only.

2.1 TERMINAL BLOCK [1]

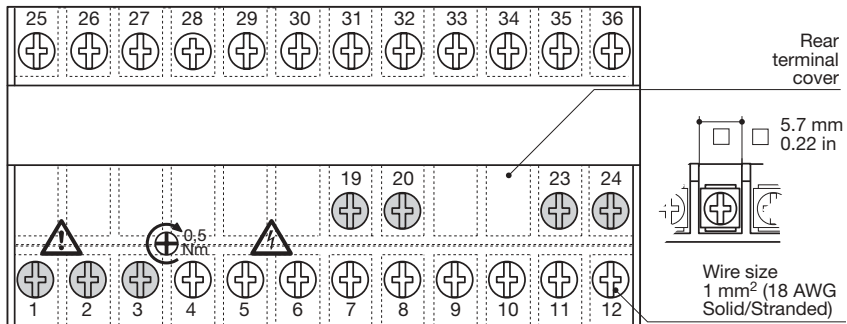

	28 screw terminals M3
	Option terminals
	Tightening torque 0.5 Nm
	Positive screw-driver PH1
	Negative screw-driver 0,8 x 4 mm

Terminals

	Pin connector ∅ 1.4 mm 0.055 in max.
	Fork-shape AMP 165004 ∅ 5.5 mm - 0.21 in
	Stripped wire L 5.5 mm - 0.21 in

PRECAUTIONS

Despite the fact that the instrument has been designed to work in harsh and noisy environments (level IV of the industrial standard IEC 801-4), it is recommended following these suggestions.



All the wiring must comply with the local regulations.

The supply wiring should be routed away from the power cables. Avoid using electromagnetic contactors, power Relays and high power motors nearby.

Avoid power units nearby, especially if controlled in phase angle mode.

Keep the low level sensor input wires away from the power lines and the output wires.

If this is not achievable, use shielded cables on the sensor input, with the shield connected to ground.

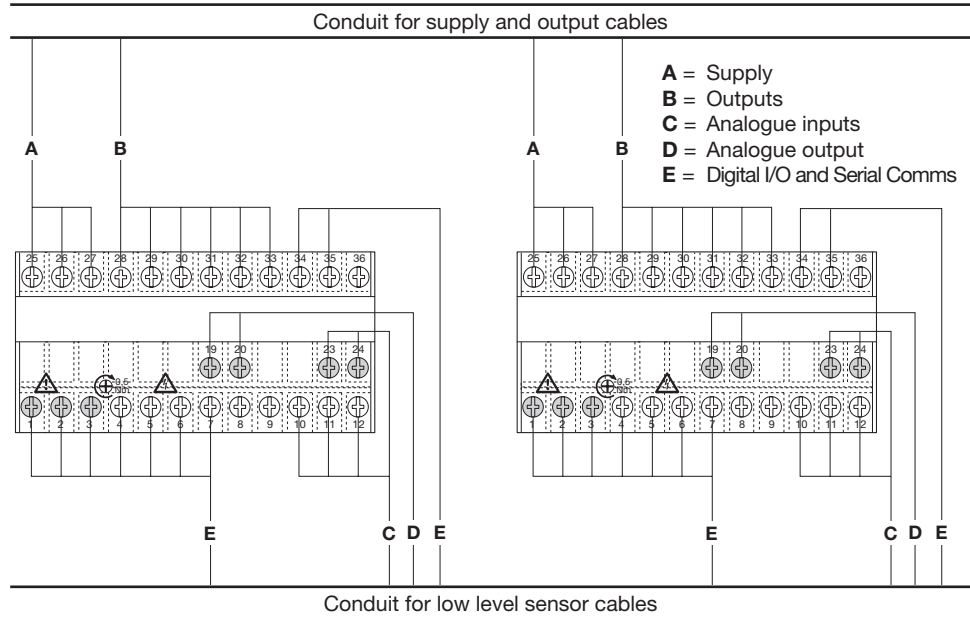
2.2 SUGGESTED WIRE ROUTING

2.3 EXAMPLE OF WIRING DIAGRAM

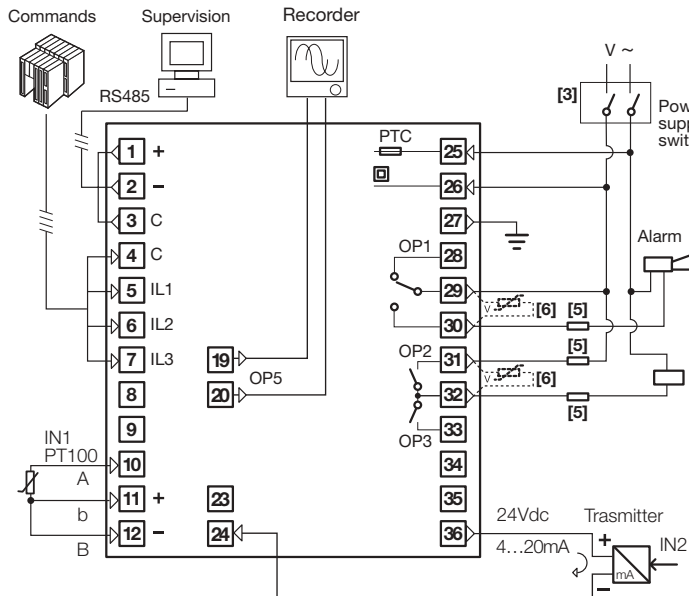
**Notes:**

- 1] Make sure that the power supply voltage is the same indicated on the instrument.
- 2] Switch on the power supply only after all the electrical connections have been completed.
- 3] In accordance with safety regulations, install a circuit breaker on the instrument power supply line that is clearly identified with that instrument (or group of instruments). The breaker shall be easily accessible by the operator.
- 4] The instrument is PTC protected. In case of failure it is suggested to return the instrument to the manufacturer for repair.
- 5] To protect the instruments internal circuits use:
 - 2 AT fuse for Relay outputs (220 Vac);
 - 4 AT fuse for Relay outputs (110 Vac);
 - 1 AacT fuse for Triac outputs.
- 6] Relay contacts are already protected with varistors.

Only in case of 24 Vac inductive loads, use model A51-065-30D7 varistors (on request)

2.3.1 POWER SUPPLY

Switching power supply with multiple isolation and internal PTC

- **Standard version:**
nominal voltage:
100...240Vac (-15...+10%)
Frequency 50/60Hz
- **Low Voltage version:**
Nominal voltage:
24Vac (-25...+12%)
Frequency 50/60Hz
or 24Vdc (-15...+25%)

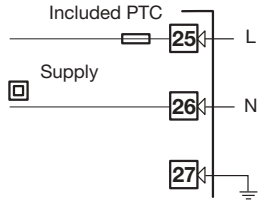

For better protection against noise, it is recommended not to connect the ground clamp provided for civilian installations.

2.3.2 MAIN UNIVERSAL INPUT (IN1)

A L-J-K-S-R-T-B-N-E-W thermocouple type

- Connect the wires with the polarity as shown
- Always use compensation cable of the correct type for the thermocouple used
- The shield, if present, must be connected to a proper ground.

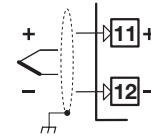

Wire resistance
150Ω max.

B For Pt100 resistance thermometer

- If a 3 wires system is used, always use cables of the same diameter (1 mm² min.) (line 20 Ω/lead maximum resistance)
- When using a 2 wire system, always use cables of the same size (1.5mm² min.) and put a jumper between terminals 11 and 12

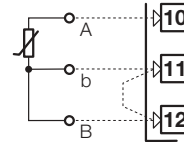

For 3 wires only.
Maximum line
resistance: 20Ω/line

C For ΔT (2x RTD Pt100) Special

- ⚠ When the distance between the indicator and the sensor is 15 m using a cable of 1.5 mm² size, produces an error on the measure of 1°C (1°F).

R1 + R2 must be <320Ω

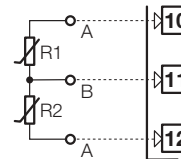

Use wires of the same
length and 1.5 mm²
size.
Maximum line
resistance: 20Ω/line

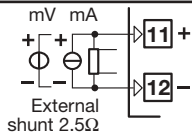
D For mA, mV

$R_j > 10M\Omega$.

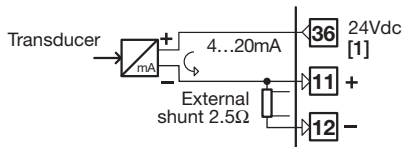
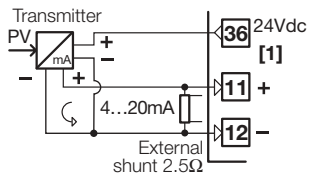
D1 With 2 wire transmitter**D2 With 3 wire transmitter****Note:**

[1] Auxiliary power supply for external transmitter
24Vdc $\pm 20\%$ /30mA max. with no short circuit protection

**2.3.3 AUXILIARY INPUT (IN2)
(OPTION)****For mA and V**

Current 0/4...20mA

Input resistance = 30 Ω

Voltage: 1...5V, 0...5V, 0...10V

Input resistance = 300k Ω

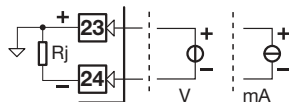
**2.3.4 DIGITAL INPUT**

- The input is active when the logic state is ON, corresponding to the contact closed
- The input is inactive when the logic state is OFF, corresponding to the contact open

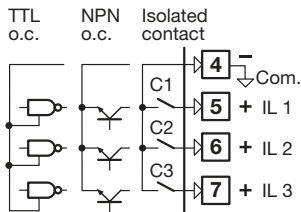
**2.3.4 OP1 - OP2 - OP3 - OP4
OUTPUTS (OPTION)**

OP1	SPDT relay output
OP2 - OP3	SPST-NO relay outputs
OP4	SSR drive or SPST-NO relay output
OP5	Retransmission analogue output

OP1 relay output:

- SPDT relay,
2A/250Vac for resistive load, fuse 2AT at 250Vac, (4A/120Vac, fuse 4AT at 120Vac).

OP2 - OP3 relay outputs

- SPST N.O. relay,
2A/250Vac for resistive load, fuse 2AT at 250Vac, (4A/120Vac, fuse 4AT at 120Vac).

OP4 not isolated SSR drive output

- 0...5Vdc, $\pm 20\%$, 30 mA max..

OP4 Relay output

- SPST relay N.O.,
2A/250Vac for resistive load, fuse 2AT at 250Vac (4A/120Vac, fuse 4AT at 120Vac).

OP5 isolated analogue output

- 0/4...20mA, 750 Ω /15V max..

2.3.5 ALARM OUTPUTS



OP1 output

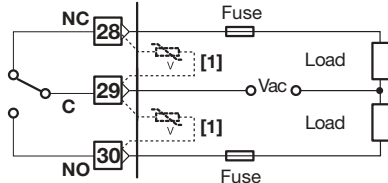

OP2, OP3 Outputs

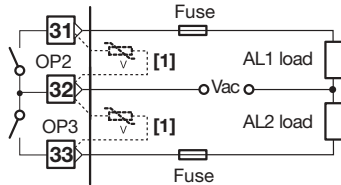

OP4 output

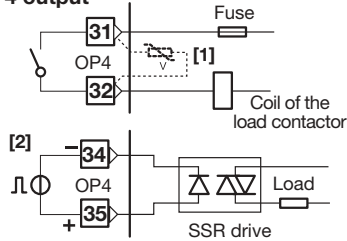

Notes:

- [1] Varistor for inductive load 24Vac only;
- [2] When basic product code **B** = 9, OP4 (terminals 34, 35) is a Relay output.

2.3.6 OP5 ANALOGUE CONTROL OUTPUT (OPTION)

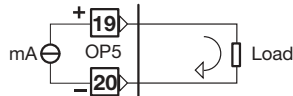

For control of IN1 or IN2 retransmission

- Galvanic isolation 500Vac/1 min.
- 0/4...20mA, (750Ω or 15Vdc max.)

2.3.7 SERIAL COMMUNICATIONS (OPTION)

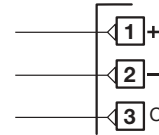

- Galvanic isolation 500Vac/1 min.
- Compliance to the EIA RS485 standard for Modbus/Jbus
- Setting dip switches

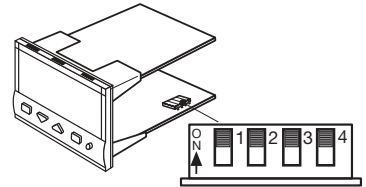

- !** Please, read: “**gammadue**® and **deltadue**® indicator series serial communication and configuration software” technical manual

3 PRODUCT CODING

The complete code is shown on the instrument label.

The information about product coding is accessible from the front panel by means of the procedure described in section 5.2 page 34.

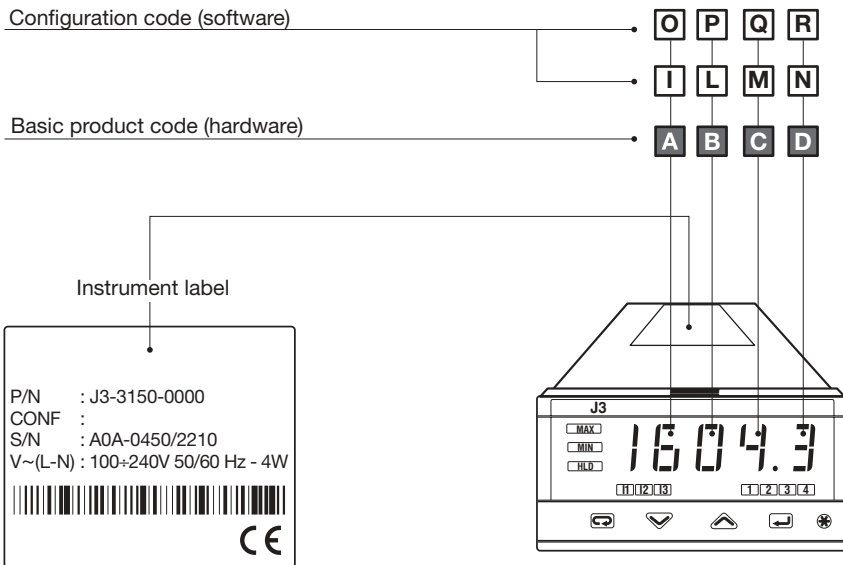

3.1 MODEL CODE

The product code indicates the specific hardware configuration of the instrument that can be modified by authorised personnel only.

Model:	Line	Basic	Accessories	Configuration	
				1st part	2nd part
	J 3	A B C D	E F G 0	I L M N	O P Q R

Line **J 3**

Power supply	A
100...240Vac (-15...+10%)	3
24Vac (-25...+12%) or 24Vdc (-15....+25%)	5

Outputs OP1 - OP2 - OP3 - OP4	B
None	0
Relay - Relay - Relay - SSR Drive	1
Relay - Relay - / - /	7
Relay - Relay - Relay - Relay	9

Serial Communications	C
None	0
RS485 Modbus/Jbus SLAVE	5

Options	D
None	0
Analog output for signal retransmission	1
Second input port IN2	2
Analog output + Second input port IN2	5

User manual	F
Italian/English (std)	0
French/English	1
German/English	2
Spanish/English	3

Front panel colour	G
Dark (std)	0
Beige	1

3.2 CONFIGURATION CODING

A 4+4 index code follows the model of the indicator.

The code has to be set to configure the indicator (see chapter 3.1 page 15)



If, when the indicator is powered up for the first time, the display shows the message:

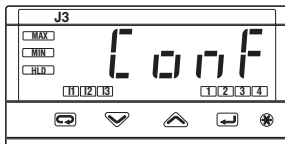

it means that the indicator has not yet been configured.

The indicator remains in standby until the configuration code is set correctly (pag. 24).

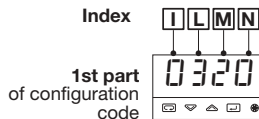

E.g. Enter the code 0320 to choose:

- T/C type J input with range 0...600°C;
- Change the display color to red when an alarm is active;
- Peak hold disabled.

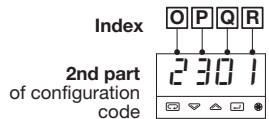

E.g. Enter the code 2301 to choose:

- AL1 absolute, active high;
- AL2 absolute, active low;
- AL3 disabled;
- Sensor break alarm.

Input type and range	I	L	
TR Pt100 IEC751	-99.9...300.0 °C	-99.9...572.0 °F	0 0
TR Pt100 IEC751	-200...600 °C	-328...1112 °F	0 1
TC L Fe-Const DIN43710	0...600 °C	32...1112 °F	0 2
TC J Fe-Cu45% Ni IEC584	0...600 °C	32...1112 °F	0 3
TC T Cu-CuNi	-200 ...400 °C	-328...752 °F	0 4
TC K Chromel-Alumel IEC584	0...1200 °C	32...2192 °F	0 5
TC S Pt10%Rh-Pt IEC584	0...1600 °C	32...2912 °F	0 6
TC R Pt13%Rh-Pt IEC584	0...1600 °C	32...2912 °F	0 7
TC B Pt30%Rh Pt6%Rh IEC584	0...1800 °C	32...3272 °F	0 8
TC N Nichrosil-Nisil IEC584	0...1200 °C	32...2192 °F	0 9
TC E Ni10%Cr-CuNi IEC584	0...600 °C	32...1112 °F	1 0
TC NI-NiMo18%	0...1100 °C	32...2012 °F	1 1
TC W3%Re-W25%Re	0...2000 °C	32...3632 °F	1 2
TC W5%Re-W26%Re	0...2000 °C	32...3632 °F	1 3
Dc input 0...50mV linear	Engineering and units		1 4
Dc input 10...50mV linear	Engineering and units		1 5
Custom input and range [1]			1 6

[1] For instance, other thermocouples types, ΔT (with 2 PT 100), custom linearisation etc.

Display mode	M
Green	0
Red	1
Red when alarm 1 (AL1) active	2
Red when at least 1 alarm is active (alarm OR)	3
Alternate between IN1, IN2 and CIN value	4
Manual forced display of IN1, IN2, CIN, Lo, Hi and Unit value	5

Hold of the peak values	N
Disabled	0
Shows the max. value (HI peak) for a programmable period of time	1
Shows the min. value (LO peak) for a programmable period of time	2

Alarm type and function		O	P	Q	R
		AL1	AL2	AL3	AL4
Non-active		0			
Sensor break alarm		1			
Absolute	Active High	2			
	Active Low	3			
Deviation	Active High	4			
	Active Low	5			
Band	Active Out	6			
	Active In	7			
Rate alarm (AL1 only)		8	-		

4 OPERATIONS

4.1.1 KEY FUNCTIONS AND DISPLAY IN OPERATOR MODE

Display mode of the Peak values

MAX or MIN LEDs will be lit when the display shows a minimum or a maximum value. HLD LED will be lit when the value displayed is locked by the HOLD command. HOLD and PEAK commands stop the measurement procedure, while the PEAK VALUES HOLD command returns to the normal operation after a programmed period of time (HLD d.t.n parameter).

Digital input status LEDs (yellows)

- I 1 - IL1 active
- I 2 - IL2 active
- I 3 - IL3 active

Menu access

Min. and Max. values display

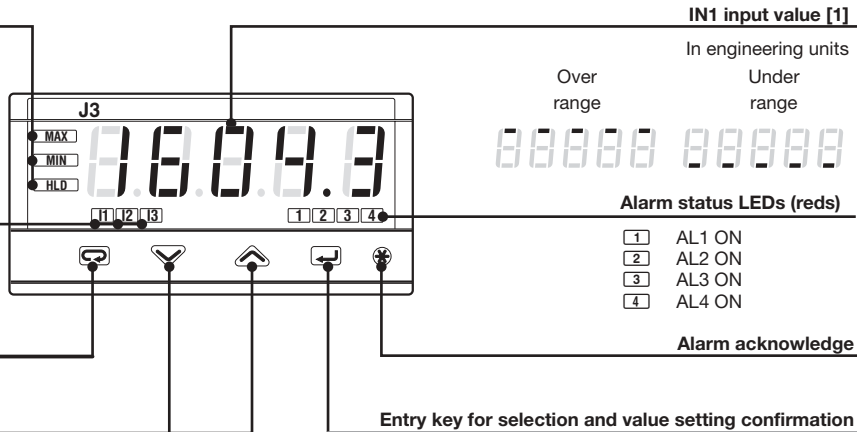



Note:

[1] The color of the display is set through field **M** of the Configuration Code (page 17).



4.1.2 KEY FUNCTIONS AND DISPLAY IN PROGRAMMING MODE



The parameter setting procedure has a timeout. If no keys are pressed for at least 30 seconds, the indicator switches back, automatically, to the operator mode.

After having selected the parameter or the code, press  and  to display or modify the value (see page 25).

The value is entered when the next parameter is selected, by pressing the  key.

Until the  or  are pressed or, if you wait for 30 seconds, the parameter value is not inserted.

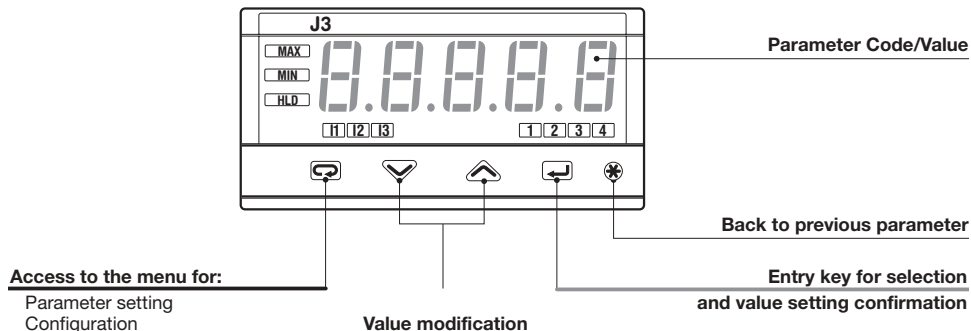

Pressing the  key, the next group of parameters is presented on the display.





4.2 PARAMETER SETTING

4.2.1 NUMERIC ENTRY

(i.e. how to modify a threshold value from 275.0 to 240.0)

Pressing  or  momentarily changes the value by 1 unit every push.

Continued pressing of  or  changes the value, at a rate that doubles every second. Releasing the button decreases the rate of change.

In any case value stops changing the max./min. value has reached limit set for the parameter.

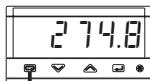

Operator mode
Displays the value of the selected input



Access the alarm threshold menu



Select the AL 1 threshold



Threshold value of AL1 alarm

Decrease





Increase





Threshold entry
Press the  key to store the new value in the instrument

4.2.2 MNEMONIC CODES SETTING

(e.g. configuration see page 30)

Press the  or  to display the next or previous mnemonic for the selected parameter.

Continued pressing of  or  will display further mnemonics at a rate of one mnemonic every 0.5 s. The mnemonic displayed at the time the next parameter is selected is the one stored in the parameter.



Engineering Units



Degree Centigrade



Degree Fahrenheit



Degree Centigrade



Degree Fahrenheit



No unit defined



Ph

4.3 PARAMETERISATION - MAIN MENU

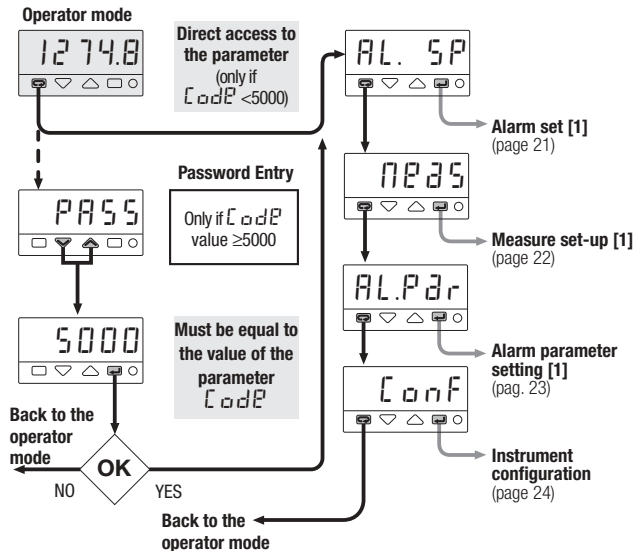
**Note:**

[1] The menu appears only if at least one of the alarms has been configured (except for the sensor break alarm).

4.3.1 ALARM SET

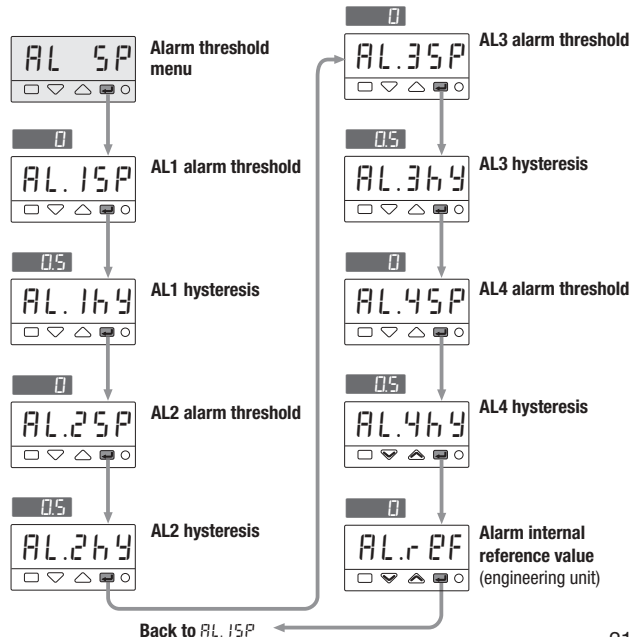

4.3.2 PARAMETERISATION - MEASURE MENU

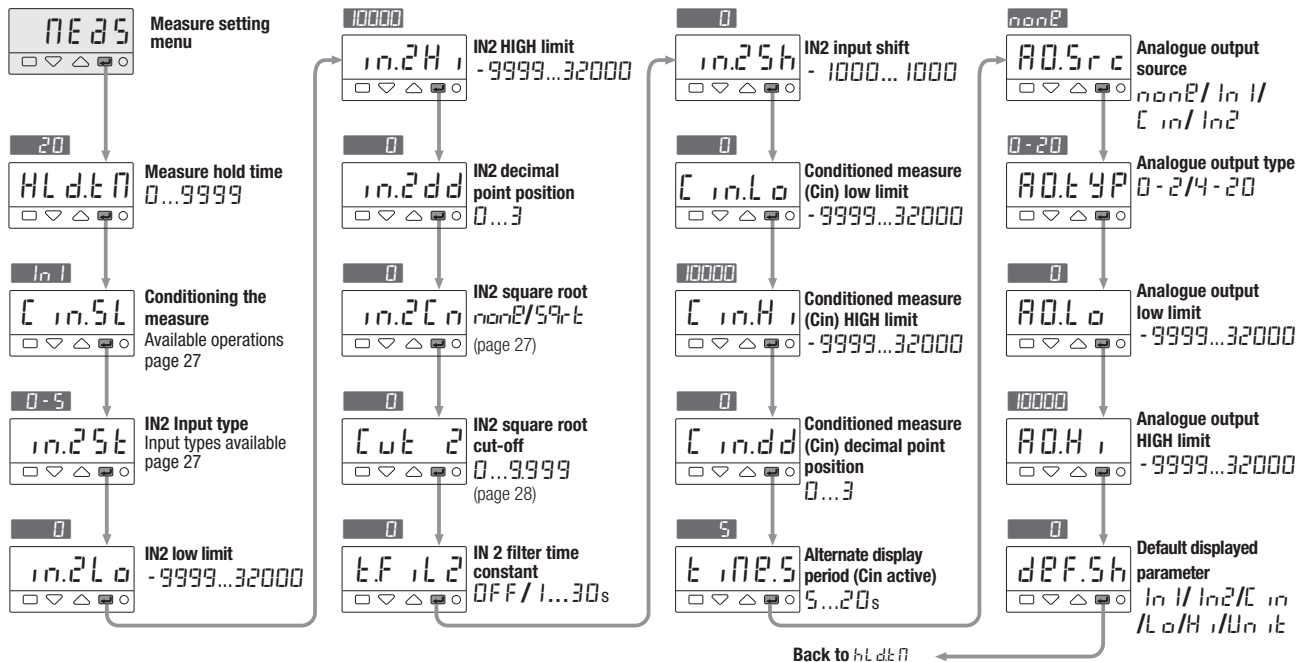

4.3.3 PARAMETERISATION - ALARMS PARAMETERISATION MENU

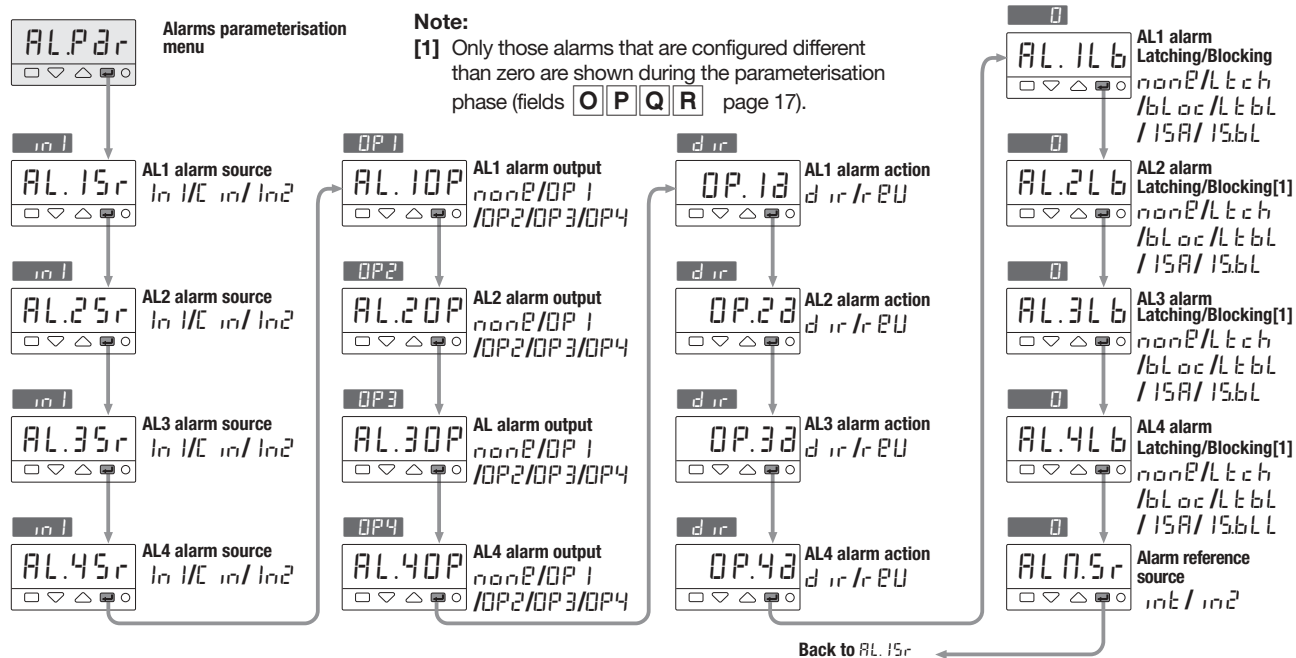

4.3.5 CONFIGURATION MENU

When an unconfigured indicator is powered up for the first time, the display shows:



See chapters 3, 3.1 and 3.2 starting from page 14.

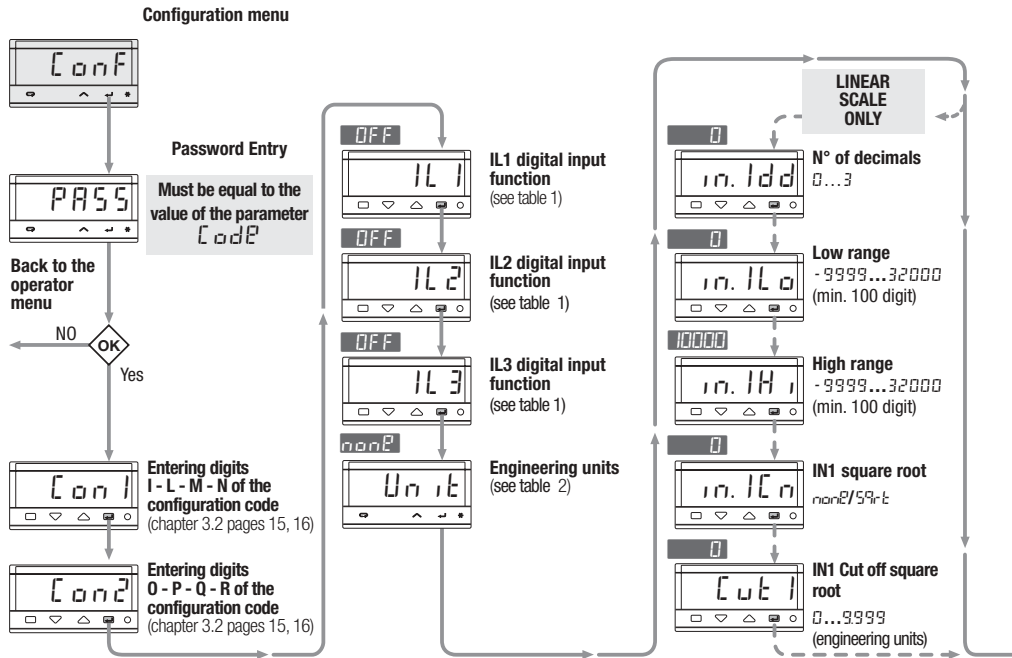

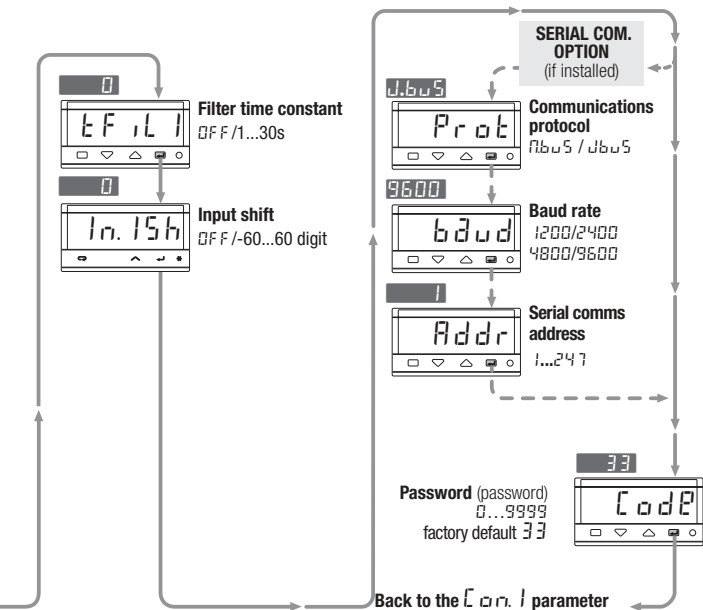
**Table 1 - Digital input functions**

Value	IL 1		IL 2		IL 3	
	Description		Value		Description	
nonE	Not used		HcPH	Positive peak enable		
EEYI	Keypad lock					
OPBL	Outputs lock		HcPL	Negative peak (valley) enable		
AcE	Alarm acknowledge		HEPH	Positive peaks sustained display		
r. HL	Max. and min. reset		HEPL	Negative peaks sustained display		
HoLd	Measure Hold		F.d ,5	Display a different parameter		

Table 2 - Engineering units

Value	Description		unit	
	Description		Value	
°C	Centigrade degrees		A	Ampere
°F	Fahrenheit degrees		bDr	Bar
nonE	none		PSI	PSI
mV	mV		rh	Rh
V	Volt		Ph	pH
mA	mA			

Note:

[1] Cut off the square root of the input value enables the user to round to zero a result that is too low to be important.

4.4 PARAMETERS DESCRIPTION

For ease of operation of the indicator, its parameters have been organised in groups (menu), according to their functionality area.

4.4.1 ALARM THRESHOLD MENU

OP1, OP2, OP3 and OP4 outputs can be used as alarms.

It is possible to configure up to 4 alarms: AL1, AL2, AL3 and AL4 (page 22) selecting for each of them:

- type and perating condition of the alarm (page 31);
- the functionality of the alarm acknowledgement (latching) **Ltch** (page 31);
- the blocking function is activated on start up **blOc** (page 31);
- Sensor break function (page 31);
- Rate alarm (only for AL1 referred to IN1).

AL.15P

AL1 alarm threshold

AL.25P

AL2 alarm threshold

AL.35P

AL3 alarm threshold

AL.45P

AL4 alarm threshold

Parameters to set the threshold of AL1, AL2, AL3 and AL4 alarms.

The range of the alarm threshold corresponds to the whole span.

When an alarm occurs, the display will shows the red LEDs **1**, **2**, **3** and **4** respectively ON and, when configured, with a change of the display colour.

AL.1hY

AL1 alarm hysteresis

AL.2hY

AL1 alarm hysteresis

AL.3hY

AL1 alarm hysteresis

AL.4hY

AL1 alarm hysteresis

Hysteresis of the threshold of AL1, AL2, AL3 and AL4 alarms. It is specified as a % of the full scale.

4.4.2 MEASURES MANAGEMENT MENU

The entries present in this menu allow the user to configure:

- the secondary input IN2;
- if a conditioning operation must be applied to the measurement;
- if a conditioning operation must be applied to the analogue output.

HL d.t.n Measure hold time

This parameter allows the configuration of the period of time a peak value must be sustained on the display.

Setting range: 5...9999 s.

C in.SL Measure conditioning

The Cin.SL parameter selects the type of operation that must be applied to input 1 (IN1) from the secondary input (IN2); the result is the conditioned input (C in).

In the table that follows are listed the possible conditioning operations:

Id	Description
in 1	Cin = IN1
in 2	Cin = IN2
Sum	Cin = IN1 + IN2
Sub	Cin = IN1 - IN2
Avg	Cin = (IN1 + IN2)/2
Max	Cin = MAX (IN1, IN2)
Min	Cin = Min (IN1, IN2)
Mult	Cin = IN1 * IN2
Div	Cin = IN1/IN2

in.2St IN2 input type

The parameter defines the range of the secondary input (IN2).

Value	Description
0-5	0...5 V
1-5	1...5 V
0-10	0...10 V
0-20	0...20 mA
4-20	4...20 mA

in.2dd Number of decimals IN2 input

in.2Lo Low range IN2 input

in.2Hi High range IN2 input

These parameters define the limits and the number of decimals to be displayed for the secondary input (IN2).

in.2Cn IN2 measure square root

Parameter to enable the calculation of the square root of the IN2 measure (Sqr = enabled, nonE = disabled)

Cut 2 Cut-off square root result

This parameter allows the user to round to zero those results that are not meaningful.

Setting range: 0...9999.

Default value: 0.

t.F IL2 **Input 2 filter time constant**

Time constant, in seconds, of the RC input filter applied to the PV input.

When this parameter is set to **OFF** the filter is bypassed.

Filter response

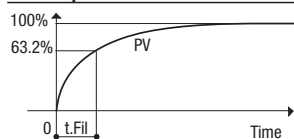

IN.256 **Secondary input (IN2) shift**

This value is added to the measured input 2 value. Its effect is to shift the whole IN2 scale of up to ± 60 digits.

Default value: 0.

C IN.DD **Number of decimals for Cin value**

C IN.L0 **Low range for conditioned value**

C IN.H1 **High range for conditioned value**

These parameters define the range and the number of decimals to be displayed for the conditioned measure (C IN).

t INE.S **Alternate display period (Cin active)**

Parameter to set the displaying time of an alternate measure when the conditioned input is active (C IN).

Setting range: 5...20 s.

Default value: 5 s.

AO.Src **Analog output source**

Selects the variable to be put on the analog output.

Values: None,
In1,
Cin,
In2.

AO.tYP **Analogue output type**

Selects the type of signal retransmitted by the analogue output.

Values: 0... 20 mA,
4... 20 mA.

Default value: 0...20mA.

AO.L0 **Analogue output low range**

AO.H1 **Analogue output high range**

Range of the analogue output.

Values:

AO.L0: -9999...32000

AO.H1: -9999...32000

Default value:

AO.L0: 0

AO.H1: 10000

DEF.Sh **Default displayed variable**

Defines the name of the variable that is displayed by default when in manual forced display mode (field **M** set to 5).

Value	Description
In1	Input 1
In2	Input 2
C IN	Conditioned input
L0	Minimum stored value
H1	Maximum stored value
Unit	Selected engineering unit

Valore di default: In1

4.4.2 ALARM PARAMETERS CONFIGURATION MENU

The entries of this menu allow the user to configure the functioning parameters of alarms AL1, AL2, AL3 and AL4.

AL1 alarm source
AL.15r

AL2 alarm source
AL.25r

AL3 alarm source
AL.35r

AL4 alarm source
AL.45r

Sets, for each alarm, the signal source to be considered.

Values: IN1, Cin; IN2.

Default value: IN1

AL1 alarm output
AL.10P

AL2 alarm output
AL.20P

AL3 alarm output
AL.30P

AL4 alarm output
AL.40P

These parameters connect each alarm to the output port to be activated when an alarm condition occurs.

Values: none, OP1, OP2, OP3, OP4.

Default values: AL1: OP1
AL2: OP2,
AL3: none
AL4: none.

Output OP1 action
OP.1a

Output OP2 action
OP.2a

Output OP3 action
OP.3a

Output OP4 action
OP.4a

Sets the type of action of the output port.

Values: direct (relay-coil activated in alarm condition), reverse (relay-coil not activated when in alarm condition).

Default values: direct.

AL1, AL2, AL3, AL4 latching and blocking function
AL.1Lb

AL.2Lb

AL.3Lb

For each alarm it is possible to select one of the following functions:

noneP none;
Letch acknowledge;
blac blocking;
Ltbl latching + blocking
15A ISA acknowledge sequence
15bL ISA acknowledge sequence + blocking

ALARM**ACKNOWLEDGE FUNCTION**

Once an alarm occurs, it is indicated on the display until it is acknowledged. To acknowledge an alarm press the \otimes key.

After this operation, the alarm shuts off only when the alarm condition is no longer present.

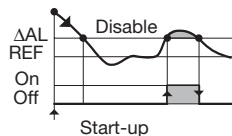
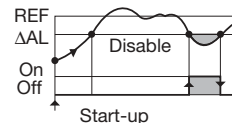
START-UP DISABLING**Ramp down****Ramp up**

$$\Delta AL \text{ Threshold} = REF \pm \text{range}$$

“ISA A” ALARM RESET SEQUENCE

The alarm intervention activates both the visual alarm (the alarm LED on the display) and the audible alarm (the OP output used to activate for example a buzzer or a siren). When the operator acknowledges the alarm, the status of the two alarms differs if the alarm condition has been removed or not. In the table that follows the visual and audible alarm status are pointed out for each condition.

Status	Status changes				Visual alarm (alarm LED)	Audible alarm (OP output)
	Input variable		Reset (ACK)			
	Normal condition	Alarm condition	Reset not done	Reset done		
No alarm active	No status changes	Go to status: Alarm not acknowledged			OFF	OFF
Alarm not acknowledged			No status changes	Go to status: Acknowledged alarm	Flashing	Active
Acknowledged alarm	Go to status: No alarm active	No status changes			Steady ON	OFF

ALN.Sr**Alarm reference source**

This parameter allows the user to select the reference value to be used for the alarms.

Valid values: Int/In2

Default: Int (as set in *ALr EF*)

4.4.3 CONFIGURATION MENU

[Conf]

1st part of the configuration code

Fields **[I]** and **[L]** allow the selection of type and range of the primary input (IN1 page 16).

Field **[M]** allows the selection of the function mode of the display (page 17).

Field **[N]** selects if and how the peak values are to be hold (or not) on the display.

[Conf2]

2nd part of the configuration code

Fields **[O]**, **[P]**, **[Q]** and **[R]** select alarm type and function (page 17).

SENSOR BREAK ALARM FUNCTION

During the configuration phase (page 17) set fields **[O]**, **[P]**, **[Q]**, **[R]**, to value 1. When the PV overcomes the sensor range limits, the sensor break alarm intervention is immediate. **When the alarm is no longer present, the alarm stops.**

ABSOLUTE ALARM

During the configuration phase (page 17) set fields **[O]**, **[P]**, **[Q]**, **[R]**, to value 2 (active high) or 3 (active low).

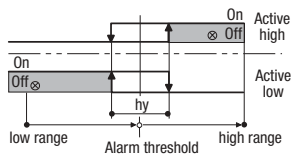

DEVIATION ALARM

During the configuration phase (page 17) set fields **[O]**, **[P]**, **[Q]**, **[R]**, to value 4 (active high) or 5 (active low).

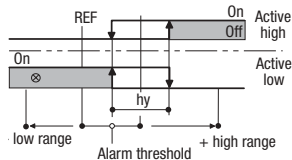

BAND ALARM

During the configuration phase (page 17) set fields **[O]**, **[P]**, **[Q]**, **[R]**, to value 5 (active in) or 6 (active out).

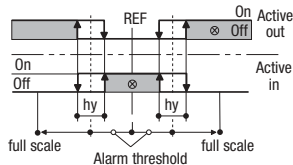

AL1 RATE ALARM FUNCTION

During the configuration phase (page 17) set fields **[O]**, to value 8. When the changing rate of the PV connected to the alarm is higher than the specified threshold, AL1 is activated.

The changing rate can be set within the limits: 0.1... 5.0 digit/s.

The alarm will be activated in 1 second if the changing rate is higher than 1 digit/s. At lower rates the alarm activation time increases to up to 6 seconds for a limit change rate of 0.1 digit/s.

IL 1

IL1 digital input function

IL 2

IL2 digital input function



IL 3

IL3 digital input function

A function is assigned, through the configuration procedure to each IL1, IL2 and IL3 digital input (see the parameters setting at table. 1 at page 31).

The configured function is activated when the digital input (free voltage contact or open collector output) is in the ON state (closed). It is deactivated by setting the input to the OFF state (open).

The activation of the function through the digital input has the highest priority than through the keypad or through the serial communications.

Function	Parameter Value	Performed operation		Notes
		 Off	 On	
None	none	—	—	Not used
Keypad lock	KEY.1	Unlocked	Locked	Also with the keypad locked the commands from digital inputs and serial communications are still operating
Outputs lock	OP.L	Normal operation	Outputs lock	Closing the contact causes the setting to the logical status 0 of the output ports. The retransmission analogue output is forced to the low limit (0 or 4 mA)
Alarm acknowledge	AcE	Normal operation	Alarm acknowledge	Closing the contact causes the acknowledgement of the active alarms
Max. and min. reset	r. HL	Normal operation	Max., min. reset	Closing the contact causes the reset of the stored maximum and minimum value
Measure hold	Hold	Normal operation	Measure held locked	Closing the contact locks the measurement of the IN1 input. In accordance, all the values directly connected to IN1 measure are locked.
Positive peak hold enable	HcPH	Normal operation	Shows the max. value read	The display shows the maximum value read all the time the contact is closed. The number displayed changes in case of higher max. values
Negative peak hold enable (valley)	HcPL	Normal operation	Shows the min. value read	The display shows the minimum value read all the time the contact is closed. The number displayed changes in case of lower min. values
Positive peaks sustained display	HEPH	Normal operation	Max. value + normal operation	The display shows, for a programmable period of time (HL dE n), the max. value read, then returns to normal operation
Negative peaks sustained display	HEPL	Normal operation	Min. value + normal operation	The display shows, for a programmable period of time (HL dE n), the min. value read, then returns to normal operation
Display a different parameter	Fd.5	Normal operation	Alternate display	For all the period the contact is closed the display shows the value of the variable set with the dE.F.5h parameter

Unit Engineering units

This parameter allows the user to view the process in the desired engineering units. When the instrument senses temperature, this parameter allows the conversion between Fahrenheit (°F) and centigrade (°C). All the engineering units available are listed at page 25 table 2.

LINEAR SCALES PARAMETERS

The parameters that follow are displayed only when, during the configuration phase, a linear input has been selected for IN1 (files **I** and **L** at page 16).

in.1dd IN1 Input number of decimals

in.1Lo IN1 input low range

in.1Hi IN1 input high range

These parameters allow the user to set the operating range and the number of decimal point to be displayed for the primary (IN1) input.

in.1Ln IN1 measure square root

Parameter to enable the calculation of the square root of the IN1 measure (*Sqr* = enabled, *nonE* = disabled)

CUT 1 Cut-off square root result

This parameter allows the user to round to zero those results that are not meaningful.
Setting range: 0...9999.
Default value: 0.

SERIAL COMMUNICATIONS PARAMETERS (OPTIONAL)

The parameters that follow are displayed only when the optional communications board is installed in the instrument.

Prot Communications protocol

baud Baud rate

Addr Instrument serial address

Values:

Protocol: Modbus/Jbus.

Baud rate: 200/2400/4800/9600 baud.

Instrument serial address: 1...247

Default values:

Protocol: Jbus.

Baud rate: 9600 baud.

Instrument serial address: 1

SAFETY PARAMETERS

Code Access code

This parameter allows the user to change the factory default password (*Code* = 33).

If *Code* is set to 0 (zero), the access to the instrument is open (no password needed).

If $0 < Code \leq 5000$ only the *CONF* menu is protected.

Codes higher than 5000

($5000 \leq Code < 10000$), protect all the 3 main menus of the instrument.

DISPLAYS

5.1 DISPLAYING THE PROCESS VARIABLES

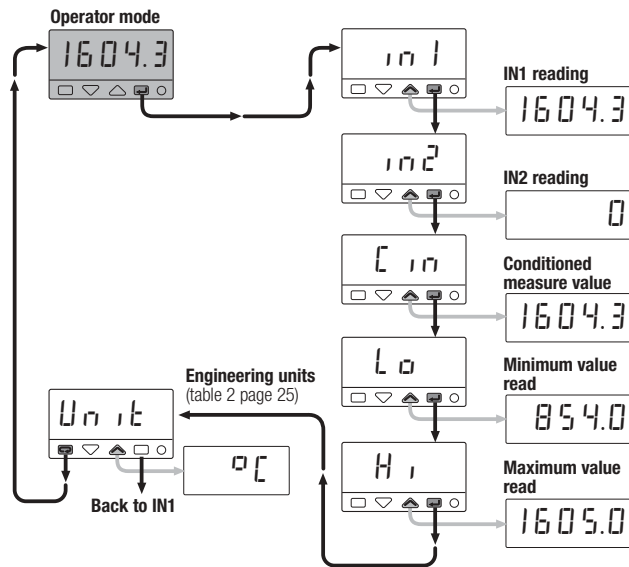

5.2 DISPLAYING THE CONFIGURATION CODES

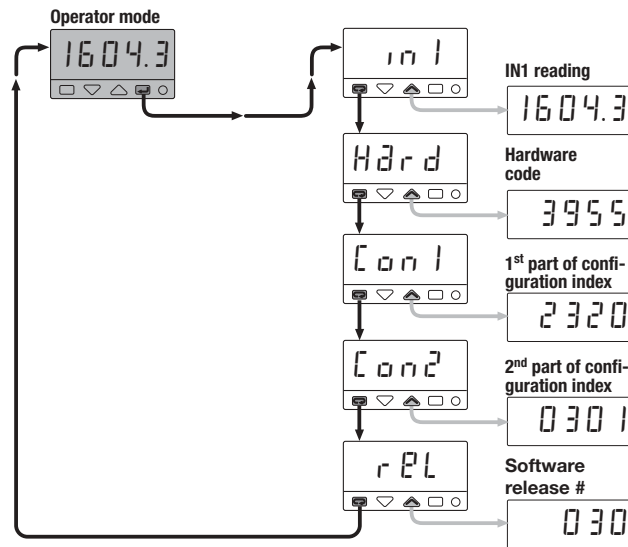

6 COMMANDS

COMMANDS TO THE INDICATOR AND OPERATING PROCEDURE

The commands can be entered in 3 ways:



6.1 KEYPAD
see page 36

- Keypad lock
- Outputs lock

6.2 DIGITAL INPUTS
see page 33

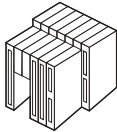



6.3 SERIAL COMMUNICATIONS
see the manual on this topic



6.1 KEYPAD COMMANDS

6.1.1 KEYPAD LOCK

To lock/unlock the keypad press and hold the keys  and  simultaneously for 2 seconds. To confirm the keypad lock/unlock the display flashes once.

The keypad lock/unlock can also be achieved over serial communications.

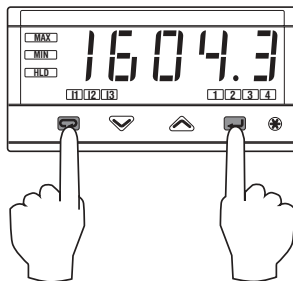

⚠ The keypad lock is retained in the event of power failure.

Operator mode



Press simultaneously
for 2 seconds

6.1.2 OUTPUTS LOCK

The outputs are switched to the OFF status by pressing and holding the keys  and  simultaneously for 2 seconds. To confirm the outputs lock/unlock the display flashes once. To unlock the outputs press the keys simultaneously again.

The outputs lock/unlock can also be achieved over serial communications.

⚠ The outputs lock is retained in the event of power failure.

Operator mode

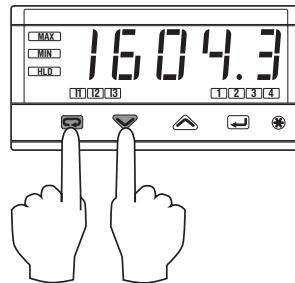

Press simultaneously
for 2 seconds

7 TECHNICAL SPECIFICATIONS

Features (at 25°C environmental temp.)	Description			
Total configurability	From keypad or serial communication the user selects: input type, type/functionality and display mode of the alarms			
IN1 Input (see pages 11,12 and 16)	Common characteristics	A/D converter with resolution of 50,000 points Update measurement time: 0.2 seconds Sampling time: 0.5 seconds Input bias: -60...+ 60 digit Input filter: 1...30 seconds (0 = disabled)		
	Accuracy	0.25% ±1 digits for temperature sensors 0.1% ±1 digits (for mV and mA)	Between 100...240 Vac the error is minimal	
	Resistance thermometer (for ΔT : R1+R2 must be <320 Ω)	Pt100 Ω at 0°C (IEC 751) °C/°F selectable	2 or 3 wire connection Burnout (with any combination)	Max. wire resist.: 20 Ω max. (3 wires) Input drift: 0.35°C/10° Env. Temp. <0.35°C/10 Ω Wire Res.
	Thermocouple	L, J, T, K, S, R, B, N, E, W3, W5 (IEC 584) Rj >10M Ω , °C/°F selectable	Internal cold junction compensation with NTC Error 1°C/20°C ±0.5°C Burnout	Line: 150 Ω max. Input drift: <2 μ V/°C Env. Temp. <5 μ V/10 Ω Wire resistance
	DC input current (with 2.5 Ω external shunt)	0... 20mA, 4... 20mA, Rj >10M Ω	Engineering units Conf. decimal point position Init. Scale -999...9999 Full Scale -999...9999 (min. range of 100 digits)	Input drift: <0.1%/20°C Env. Temp.
IN2 secondary input (option)	DC input current	0... 20mA, 4... 20mA, Rj = 30 Ω		
	DC input voltage	0...5V, 1...5V, 1...10V, Rj = 300k Ω		
Digital inputs (3) (not isolated)	Closing an external contact is possible to: Lock the keypad, lock the output, acknowledge alarms, reset min./max. stored values, Hold the measure, Hold/sustained display of positive/negative peaks, force the display of a different parameter			

7 - Technical specification

Features (at 25°C environmental temp.)	Description			
OP1 outputs	SPDT relay, 2A/250Vac (4A/120Vac) for resistive load			
OP2- OP3 outputs	SPST Relay N.O., 2A/250Vac (4A/120Vac) for resistive load			
OP4 outputs	Logic not isolated: 0/5Vdc, ±10% 30mA max. - SPST Relay N.O., 2A/250Vac (4A/120Vac) for resistive load			
OP5 analogue output (option)	For retransmission of: IN1 IN2 Conditioned measure (Cin)	Galvanic isolation: 500 Vac/1 min Resolution 12bit (0.025%) Accuracy: 0.1 %	In current: 0/4...20mA 750Ω/15V max.	
AL1 - AL2 - AL3 - AL4 alarms	Hysteresis 0.1...10.0% c.s.			
	Action	Active high	Action type	Changing rate threshold 0.1...5.0 digit/s
		Active low		Deviation threshold ±range
		Band threshold 0...range		
		Absolute threshold whole range		
Special functions	Sensor break Acknowledge (latching), activation inhibit (blocking), OR function, ISA-A acknowledge sequence			

Features (at 25°C environmental temp.)	Description	
Serial comm. (option)	RS485 isolated, Modbus/Jbus protocol, 1200, 2400, 4800, 9600 bit/s, 3 wires	
Auxiliary Supply	+24Vdc \pm 20% 30mA max. - for external transmitter supply	
Operational Safety	Measure input	Detection of out of range, short circuit or sensor break with automatic activation of the safety strategies and alerts on display
	Outputs	Safety value: -100...100%
	Parameters	Parameter and configuration data are stored in a non-volatile memory for an unlimited time
	Access protection	Password to access the configuration and parameter data, keypad lock, outputs lock
General characteristics	Power supply (PTC protected)	100...240Vac (-15...+10%) 50/60 Hz or 24Vac (-25...+12%), 50/60 Hz and 24Vdc (-15...+25%) Power consumption 4W max.
	Safety	Compliance to EN61010-1 (IEC 1010 – 1), installation class 2 (2.5kV) pollution class 2, instrument class II
	Electromagnetic compatibility	Compliance to the CE standards (see page 2)
	UL and cUL Approvals	File 176452
	Protection EN60529 (IEC 529)	IP65 front panel
	Dimensions	$\frac{1}{8}$ DIN - 96 x 48, depth 110 mm, weight 250 g approx.



WARRANTY

We warrant that the products will be free from defects in material and workmanship for 3 years from the date of delivery.

The warranty above shall not apply for any failure caused by the use of the product not in accordance with the instructions contained in this manual.

ASCON'S WORLDWIDE SALES NETWORK

SUBSIDIARY

FRANCE

ASCON FRANCE

Phone: +33 (0) 1 64 30 62 62

Fax +33 (0) 1 64 30 84 98

AGENCE EST

Phone: +33 (3) 89 76 99 89

Fax +33 (3) 89 76 87 03

AGENCE SUD-EST

Phone: +33 (0) 4 74 27 82 81

Fax +33 (0) 4 74 27 81 71

USA

ASCON CORPORATION

Phone: +1 630 482 2950

Fax +1 630 482 295

DISTRIBUTORS

ARGENTINA

MEDITECNA S.R.L.

Phone +5411 4585 7005

Fax +5411 4585 3434

FINLAND & ESTONIA

THT CONTROL OY

Phone +358 3 212 9400

Fax +358 3 212 9404

GERMANY

MESA INDUSTRIE ELEKTRONIK GMBH

Phone +49 2365 915 220

Fax +49 2365 915 225

GREECE

CONTROL SYSTEM

Phone +30 31 521 055-6

Fax +30 31 515 495

BRANCH OFFICE

Phone +30 1 646 6276

Fax +30 1 646 6862

PORTUGAL

REGIQUIPAMENTOS LDA

Phone +351 21 989 0738

Fax +351 21 989 0739

SPAIN

INTERBIL S.L.

Phone +34 94 453 50 78

Fax +34 94 453 51 45

BRANCH OFFICE

Phone +34 93 311 98 11

Fax +34 93 311 93 65

Phone +34 918 969 111

Fax +34 918 969 112

SWITZERLAND

CONTROLTHERM GMBH

Phone +41 44 954 37 77

Fax +41 44 954 37 78

TURKEY

KONTROL SISTEMLERI LTD

Phone +90 216 302 19 70-71

Fax +90 216 302 19 72











UNITED KINGDOM













EUKERO CONTROLS LTD











Phone +44 20 8568 4664

Fax +44 20 8568 4115

ICONS TABLE

Main universal input	
	Thermocouple
	RTD (Pt100)
	Delta Temp (2x RTD)
	mA and mV
	Custom
	Frequency
Auxiliary input	
	Current transformer
	mA Remote setpoint
	Volt Remote setpoint
	Feedback potentiometer

Digital input	
	Isolated contact
	NPN open collector
	TTL open collector
Setpoint	
	Local
	Stand-by
	Keypad lock
	Outputs lock
	Start-up function
	Timer function
	Memorized
	Remote
	Setpoint programmer

Digital input connected functions	
	Auto/Manual
	Run, Hold, Reset and program selection
	PV hold
	Setpoint slopes inhibition
Output	
	SPST Relay
	Triac
	SPDT Relay
	mA
	mA mV
	Logic