



ASCON spa

ISO 9001
Certified

ASCON spa
via Falzarego, 9/11
20021 Bollate
(Milano) Italy
Fax +39 02 350 4243
<http://www.ascon.it>
e-mail support@ascon.it

Two alarms indicator

1/8 DIN - 96 x 48



J1 line

User Manual • M.I.U.J1 - 3/09.02 • Cod. J30-478-1AJ1 IE



Two alarms indicator

1/8 DIN - 96 x 48

J1 line

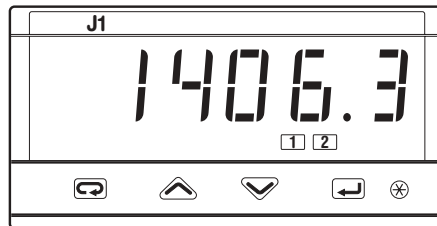



NOTES

ON ELECTRIC SAFETY AND ELECTROMAGNETIC COMPATIBILITY

Please, read these instructions carefully before proceeding with the installation of the controller.

Class II instrument, rear panel mounting.

This indicator has been designed in compliance with:

Regulations on electrical apparatus (appliance, systems and installations) according to the European Community directive 73/23/EEC amended by the European Community directive 93/68/EEC and the Regulations on the essential protection requirements in electrical apparatus EN61010-1: 93 + A2:95.

Regulations on Electromagnetic Compatibility according to the European Community directive #89/336/EEC, amended by the European Community directive #92/31/EEC, 93/68/EEC, 98/13/EEC and the following regulations:

Regulations on RF emissions

EN61000-6-3: 2001 residential environments

EN61000-6-4: 2001 industrial environments

Regulation on RF immunity

EN61000-6-2: 2001 industrial equipment and system

It is important to understand that it's the responsibility of the installer to ensure compliance with the regulations on safety requirements and EMC.

The device has no user serviceable parts and requires special equipment and specialised engineers. Therefore, a repair cannot be carried out directly by the user. For service or repair, contact the manufacturer or your sales representative.

All the information and warnings about safety and electromagnetic compatibility are marked with the  sign, at the side of the note.

TABLE OF CONTENTS



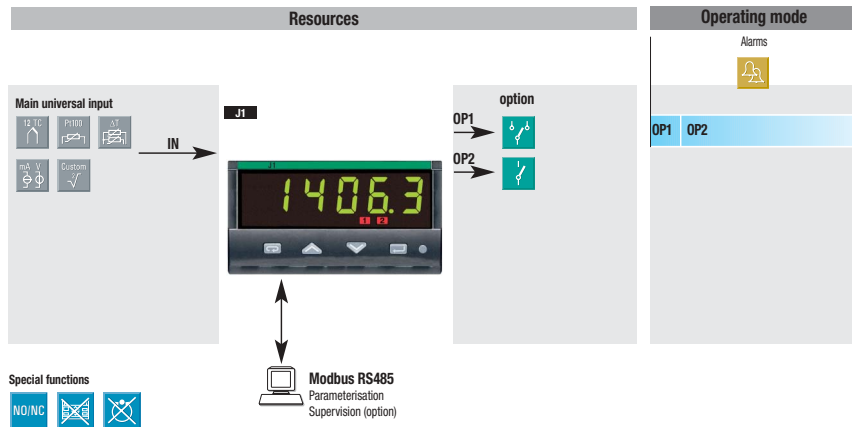

| | | | |
|----------|---------------------------------------|------|----|
| 1 | INSTALLATION | Page | 4 |
| 2 | ELECTRICAL CONNECTIONS | Page | 8 |
| 3 | PRODUCT CODING | Page | 14 |
| 4 | OPERATIONS | Page | 18 |
| 5 | DISPLAYS | Page | 28 |
| 6 | COMMANDS | Page | 29 |
| 7 | TECHNICAL SPECIFICATIONS | Page | 31 |

INSTALLATION

1.1 GENERAL DESCRIPTION

Installation must only be carried out by qualified personnel.

Before proceeding with the installation of this indicator follow the instructions illustrated in this manual with particular attention to the installation precautions marked with the   symbol, related to the European Community directive on electrical protection and electromagnetic compatibility.



To prevent hands or metal touching parts that may be electrically live, **the indicators must be installed in an enclosure.**

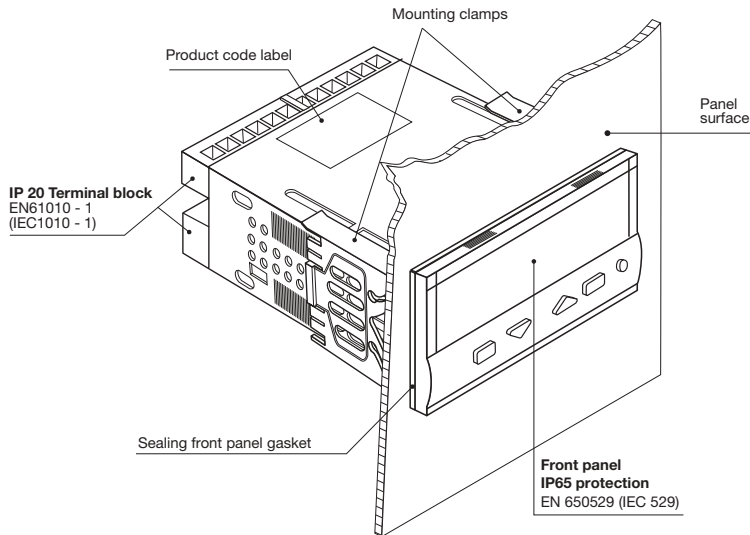

1.2 DIMENSIONAL DETAILS

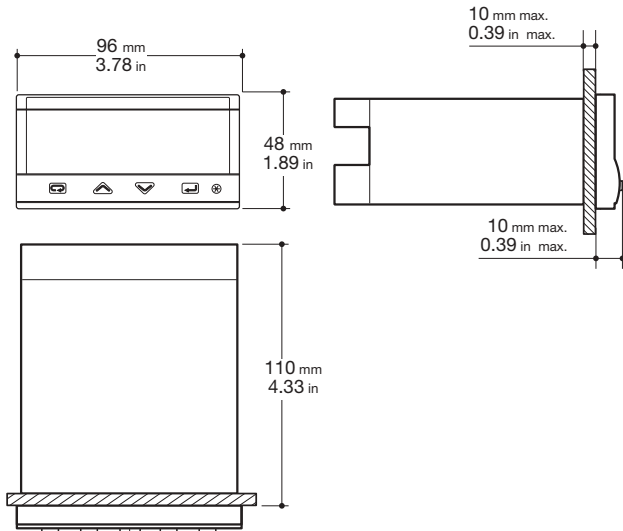

1.3 PANEL CUT-OUT

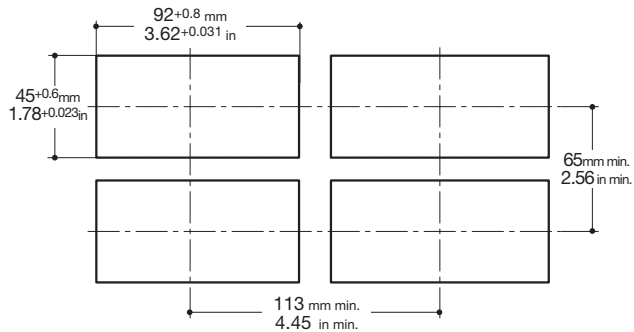

1.4 ENVIRONMENTAL CONDITIONS



Operating conditions



Altitude up to 2000 m



Temperature 0...50°C [1]

%Rh

Relative humidity 5...95 % non-condensing

Special conditions

Suggestions



Altitude > 2000 m

Use 24Vac supply version



Temperature >50°C

Use forced air ventilation

%Rh

Humidity > 95 %

Warm up



Conducting atmosphere

Use filter

Forbidden Conditions



Corrosive atmosphere



Explosive atmosphere

UL note

[1] Operating surrounding temperature
0...50°C

1.5 PANEL MOUNTING [1]

1.5.1 INSERT THE INSTRUMENT

- 1 Prepare panel cut-out
- 2 Check-front panel gasket position
- 3 Insert the instrument through the cut-out

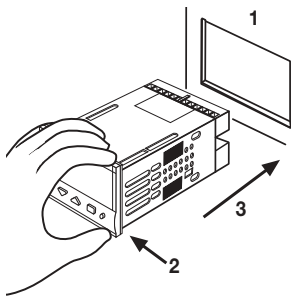

1.5.2 INSTALLATION SECURING

- 1 Fit the mounting clamps as shown
- 2 Push the mounting clamps towards the panel surface to secure the instrument

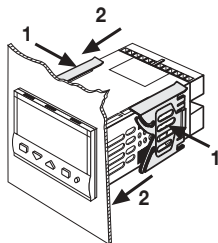

1.5.3 CLAMPS REMOVING

- 1 Insert the screwdriver in the clips of the clamps
- 2 Rotate the screwdriver

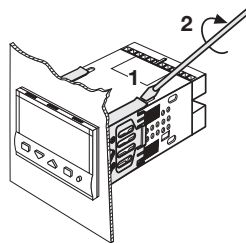

1.5.4 INSTRUMENT UNPLUGGING



- 1 Push and
- 2 Pull forward to remove the instrument

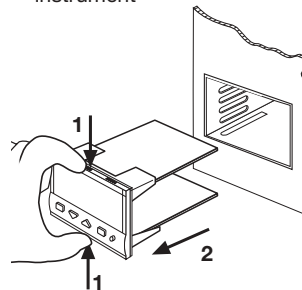

Electrostatic discharges can damage the instrument. Before removing the instrument the operator must discharge himself to ground.

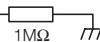

UL note

[1] For Use on a Flat Surface of a Type 2 and Type 3 'raintight' Enclosure.

ELECTRICAL CONNECTIONS

2.1 TERMINAL BLOCK [1]

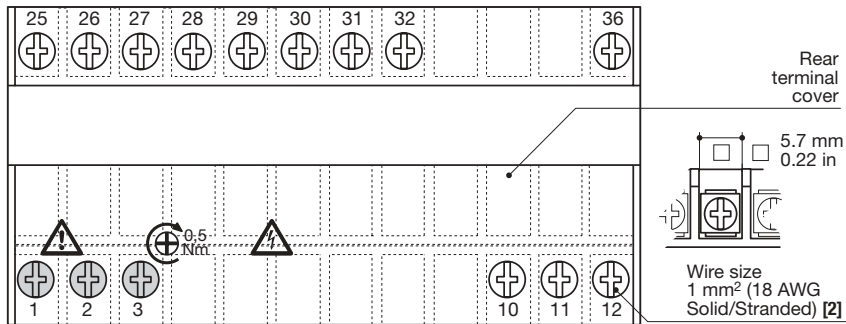
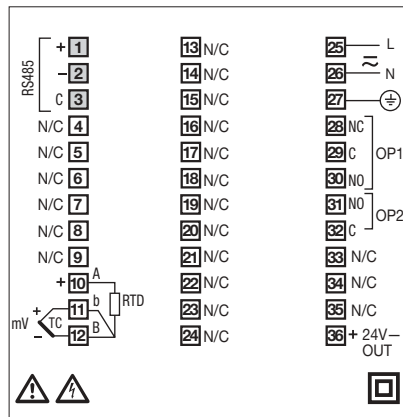

UL notes

- [1] Use 60/70 °C copper (Cu) conductor only.
[2] Wire size 1 mm² (18 AWG Solid/Stranded)

| | |
|--|------------------------------------|
| | 15 screw terminals M3 |
| | Option terminals |
| | Tightening torque 0.5 Nm |
| | Phillips screw-driver PH1 |
| | Flat blade screw-driver 0.8 x 4 mm |

Terminals

| | |
|--|---|
| | Pin connector ∅ 1.4 mm 0.055 in max. |
| | Fork-shape AMP 165004 ∅ 5.5 mm - 0.21 in |
| | Stripped wire L 5.5 mm - 0.21 in |

PRECAUTIONS

Despite the fact that the instrument has been designed to work in a harsh and noisy environment (level IV of the industrial standard IEC 801-4), it is recommended these following suggestions.



All the wiring must comply with the local regulations. The supply wiring should be routed away from the power cables. Avoid using electromagnetic contactors, power Relays and high power motors nearby. Avoid power units nearby, especially if controlled in phase angle mode.

Keep the low level sensor input wires away from the power lines and the output wires. If this is not feasible, use shielded cables on the sensor input, with the shield connected to ground.

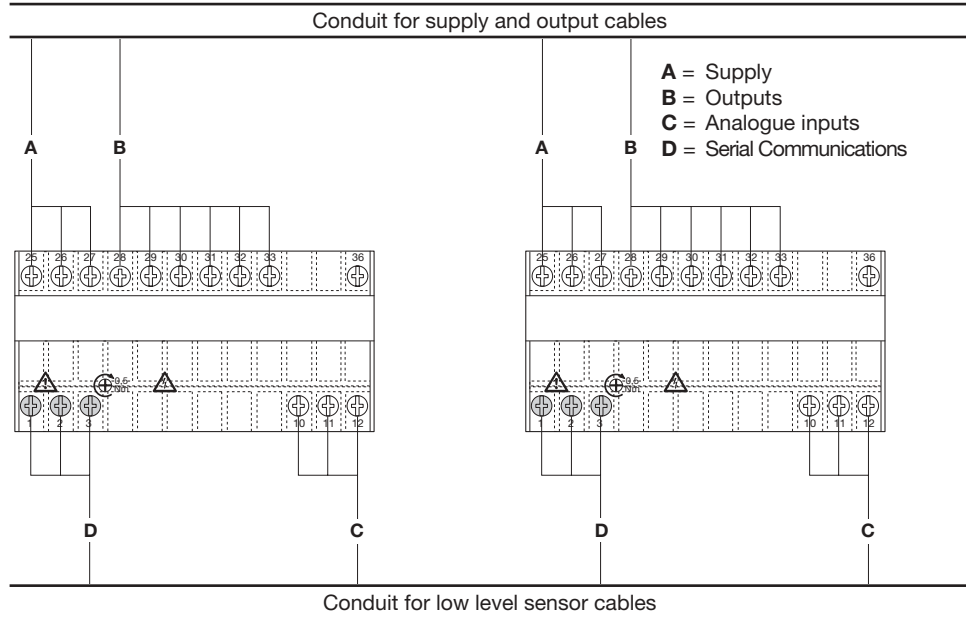
2.2 SUGGESTED WIRE ROUTING

2.3 EXAMPLE OF WIRING DIAGRAM

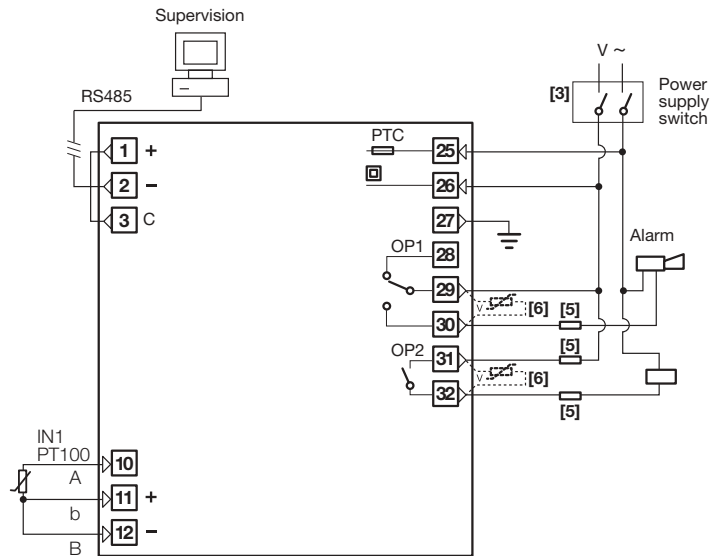
**Notes:**

- 1] Make sure that the power supply voltage is the same as indicated on the instrument.
- 2] Switch on the power supply only after all the electrical connections have been completed.
- 3] In accordance with safety regulations, install a circuit breaker on the instrument power supply line that is clearly identified with that instrument (or group of instruments). The breaker shall be easily accessible by the operator.
- 4] The instrument is PTC protected. In case of failure it is suggested to return the instrument to the manufacturer for repair.
- 5] To protect the instrument internal circuits use:
 - 2 AT fuse for Relay outputs (220 Vac);
 - 4 AT fuse for Relay outputs (110 Vac).
- 6] Relay contacts are already protected with varistors.

Only in case of 24 Vac inductive loads, use model A51-065-30D7 varistors (on request)

2.3.1 POWER SUPPLY

Switching power supply with multiple isolation and internal PTC

- **Standard version:**
nominal voltage:
100...240Vac (-15...+10%)
Frequency 50/60Hz
- **Low Voltage version:**
Nominal voltage:
24Vac (-25...+12%)
Frequency 50/60Hz
or 24Vdc (-15...+25%)

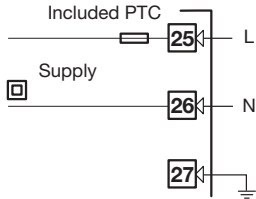

For better protection against electrical interference, it is recommended not to connect the ground clamp provided for civilian installations.

2.3.2 MAIN UNIVERSAL INPUT

A L-J-K-S-R-T-B-N-E-W thermocouple type

- Connect the wires with the polarity as shown;
- Always use compensation cable of the correct type for the thermocouple used;
- The shield, if present, must be connected to a proper ground.

B For Pt100 resistance thermometer

- If a 3 wire system is used, always use cables of the same diameter (1 mm² min.) (line 20 Ω/lead maximum resistance);
- When using a 2 wires system, always use cables of the same size (1,5 mm² min.) and put a jumper between terminals 11 and 12.

C For ΔT (2x RTD Pt100) Special

-  When the distance between the indicator and the sensor is 15 m using a cable of 1.5 mm² size produces an error on the measure of 1°C (1°F).

R1 + R2 must be <320Ω

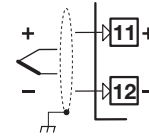

Wire resistance
150Ω max.

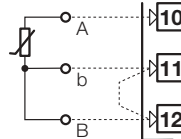

For 3 wires only.
Maximum line
resistance: 20Ω/line

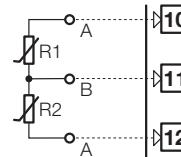

Use wires of the same
length and 1.5 mm²
size.
Maximum line
resistance: 20Ω/line

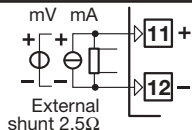
D For mA, mV

$R_j > 10M\Omega$.

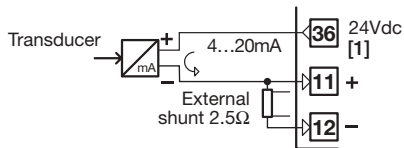
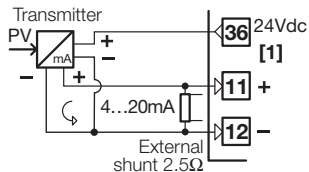
D1 With 2 wire transmitter**D2 With 3 wire transmitter****Note:**

[1] Auxiliary power supply for external transmitter 24Vdc $\pm 20\%$ /30mA max. with no short circuit protection

2.3.3 OP1 - OP2

OP1 SPDT relay output

OP2 SPST-NO relay output

OP1 relay output:

- SPDT relay,
2A/250Vac for resistive load, fuse 2AT at 250Vac, (4A/120Vac, fuse 4AT at 120Vac).

OP2 relay output:

- SPST N.O. relay,
2A/250Vac for resistive load, fuse 2AT at 250Vac, (4A/120Vac, fuse 4AT at 120Vac).

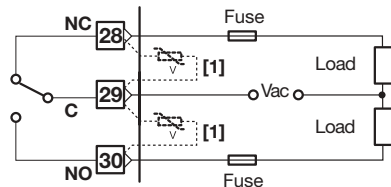
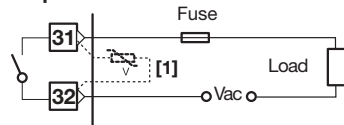
2.3.4 ALARM OUTPUTS**OP1 output****OP2 output****Notes:**

[1] Varistor for inductive load 24Vac only.

2.3.5 SERIAL COMMUNICATIONS (OPTION)

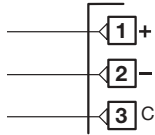

- Galvanic isolation 500Vac/1 min.
- Compliance to the EIA RS485 standard for Modbus/Jbus
- Setting dip switches

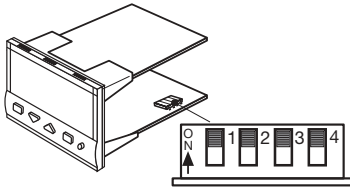

 Please, read:
 “**gammadue**[®] and **delta due**[®] indicator series serial communication and configuration software” technical manual

3 PRODUCT CODING

The complete code is shown on the instrument label.

The information about product coding is accessible from the front panel by means of the procedure described in section 5.2 page 28.

Configuration code (software)

Basic product code (hardware)

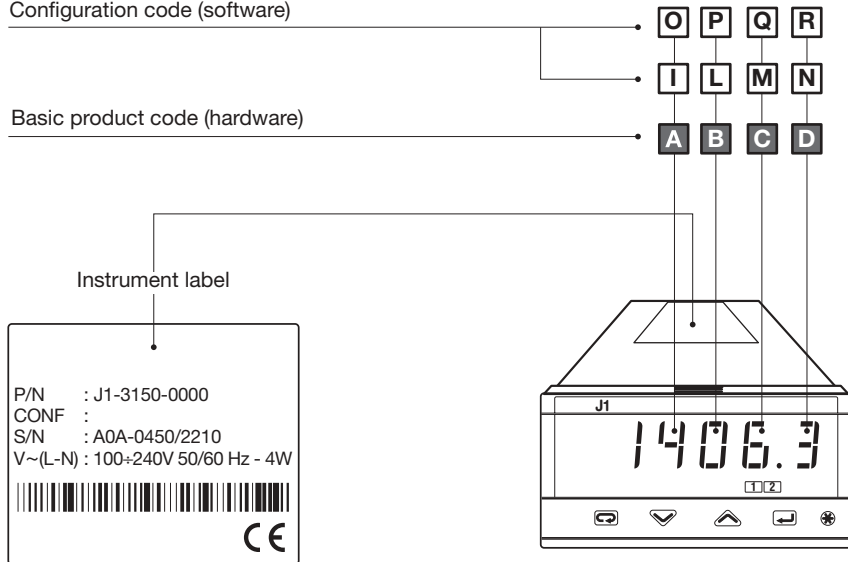

3.1 MODEL CODE

The product code indicates the specific hardware configuration of the instrument that can be modified by authorized personnel only.

Model: **J 1** **A B C 0** - **0 F G 0** / **I L M 0** - **O P 0 0**

Configuration
1st part 2nd part

Line **J 1**

| Power supply | A |
|---|----------|
| 100...240Vac (-15...+10%) | 3 |
| 24Vac (-25...+12%) or 24Vdc (-15....+25%) | 5 |

| Outputs OP1 - OP2 | B |
|--------------------------|----------|
| None | 0 |
| Relay - Relay | 7 |

| Serial Communications | C |
|------------------------------|----------|
| None | 0 |
| RS485 Modbus/Jbus SLAVE | 5 |

| User manual | F |
|-----------------------|----------|
| Italian/English (std) | 0 |
| French/English | 1 |
| German/English | 2 |
| Spanish/English | 3 |

| Front panel colour | G |
|---------------------------|----------|
| Dark (std) | 0 |
| Beige | 1 |

3.2 CONFIGURATION CODING

A 4+4 index code follows the model of the indicator.

The code has to be set to configure the indicator (see chapter 3.1 page 15)



If, when the indicator is powered up for the first time, the display shows the following message

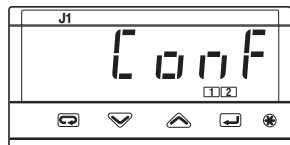

it means that the indicator has not yet been configured.

The indicator remains in stand-by until the configuration code is set correctly (pag. 24).

Index I L M N

1st part
of configuration
code



- E.g. Enter the code 0320 to choose:
- T/C type J input with range 0...600°C;
 - Change the display color to red when an alarm is active.

Index O P Q R

2nd part
of configuration
code

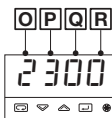

- E.g. Enter the code 2300 to choose:
- AL1 absolute, active high;
 - AL2 absolute, active low.

| Input type and range | I | L | |
|-------------------------------|-----------------------|------------------|-----|
| TR Pt100 IEC751 | -99.9...300.0 °C | -99.9...572.0 °F | 0 0 |
| TR Pt100 IEC751 | -200...600 °C | -328...1112 °F | 0 1 |
| TC L Fe-Const DIN43710 | 0...600 °C | 32...1112 °F | 0 2 |
| TC J Fe-Cu45% Ni IEC584 | 0...600 °C | 32...1112 °F | 0 3 |
| TC T Cu-CuNi | -200 ...400 °C | -328...752 °F | 0 4 |
| TC K Chromel-Alumel IEC584 | 0...1200 °C | 32...2192 °F | 0 5 |
| TC S Pt10%Rh-Pt IEC584 | 0...1600 °C | 32...2912 °F | 0 6 |
| TC R Pt13%Rh-Pt IEC584 | 0...1600 °C | 32...2912 °F | 0 7 |
| TC B Pt30%Rh Pt6%Rh IEC584 | 0...1800 °C | 32...3272 °F | 0 8 |
| TC N Nichrosil-Nisil IEC584 | 0...1200 °C | 32...2192 °F | 0 9 |
| TC E Ni10%Cr-CuNi IEC584 | 0...600 °C | 32...1112 °F | 1 0 |
| TC NI-NiMo18% | 0...1100 °C | 32...2012 °F | 1 1 |
| TC W3%Re-W25%Re | 0...2000 °C | 32...3632 °F | 1 2 |
| TC W5%Re-W26%Re | 0...2000 °C | 32...3632 °F | 1 3 |
| Dc input 0...50mV linear | Engineering and units | | 1 4 |
| Dc input 10...50mV linear | Engineering and units | | 1 5 |
| Custom input and range [1] | | | 1 6 |

[1] For instance, other thermocouples types, ΔT (with 2 PT 100), custom linearisation etc.

| Display mode | M |
|-------------------------------|----------|
| Green | 0 |
| Red | 1 |
| Red when alarm 1 (AL1) active | 2 |

| Alarm type and function | O | P |
|--------------------------------|-------------|------------|
| | AL1 | AL2 |
| Non-active | 0 | |
| Sensor break alarm | 1 | |
| Absolute | Active High | 2 |
| | Active Low | 3 |
| Deviation | Active High | 4 |
| | Active Low | 5 |
| Band | Active Out | 6 |
| | Active In | 7 |
| Rate alarm (AL1 only) | 8 | - |

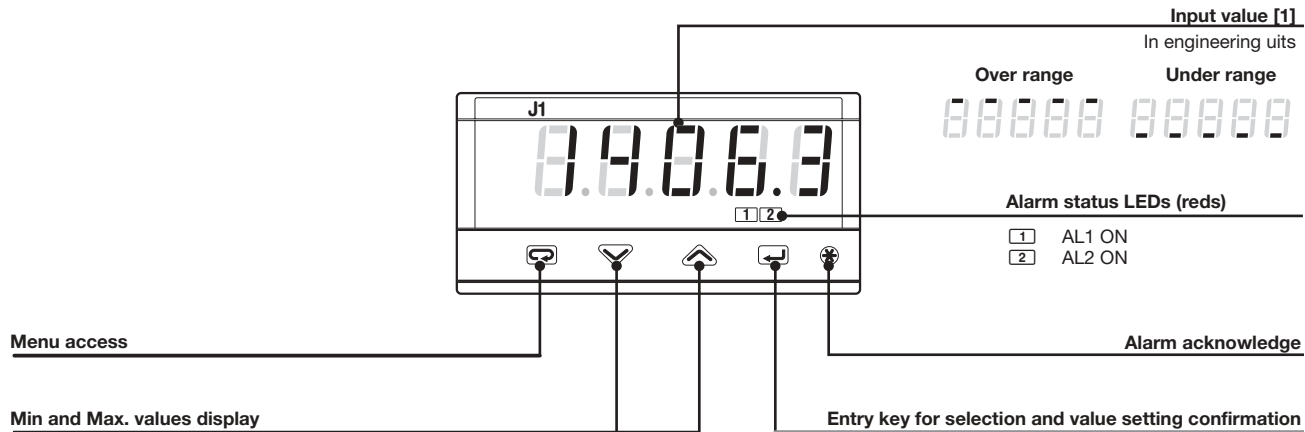

4 OPERATIONS**4.1.1 KEY FUNCTIONS AND DISPLAY IN OPERATOR MODE****Note:**

[1] The colour of the display is set through field **M** of the Configuration Code (page 17).



4.1.2 KEY FUNCTIONS AND DISPLAY IN PROGRAMMING MODE



The parameter setting procedure has a timeout. If no keys are pressed for, at least 30 seconds, the indicator switches back, automatically, to the operator mode.

After having selected the parameter or the code, press  and  to display or modify the value (see page 20).

The value is entered when the next parameter is selected, by pressing the  key.

Until the  or  are pressed or if you wait for 30 seconds, the parameter value is not inserted.

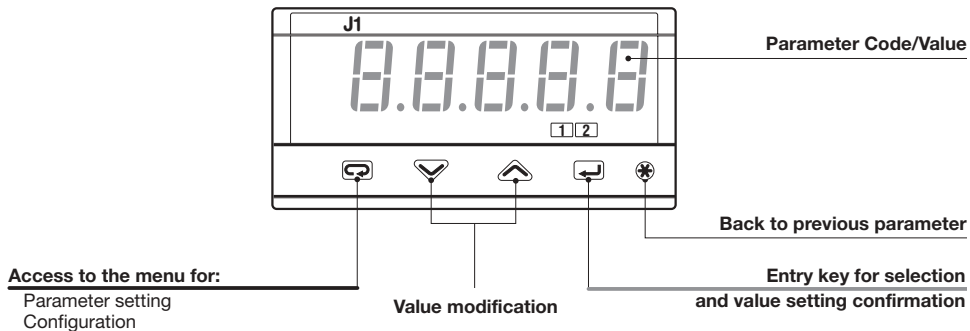

Pressing the  key, the next group of parameters is presented on the display.





4.2 PARAMETER SETTING

4.2.1 NUMERIC ENTRY

(i.e. how to modify a threshold value from 275.0 to 240.0)

Pressing  or  momentarily changes the value by 1 unit every push.

Continued pressing of  or  changes the value, at a rate that doubles every second. Releasing the button decreases the rate of change.

In any case value stops changing the max./min. value has reached limit set for the parameter.



Operator mode
Displays the value of the selected input



Access the alarm threshold menu



Select the AL 1 threshold



Threshold value of AL1 alarm

Decrease





Increase





Threshold entry
Press the  key to store the new value in the instrument

4.2.2 MNEMONIC CODES SETTING

(e.g. configuration see page 30)

Press the  or  to display the next or previous mnemonic for the selected parameter.

Continued pressing of  or  will display further mnemonics at a rate of one mnemonic every 0.5 s. The mnemonic displayed at the time the next parameter is selected is the one stored in the parameter.



Engineering Units



Degree Centigrade



Degree Fahrenheit



Degree Centigrade

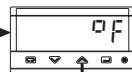

Degree Fahrenheit



No unit defined



Ph

4.3 PARAMETERISATION - MAIN MENU

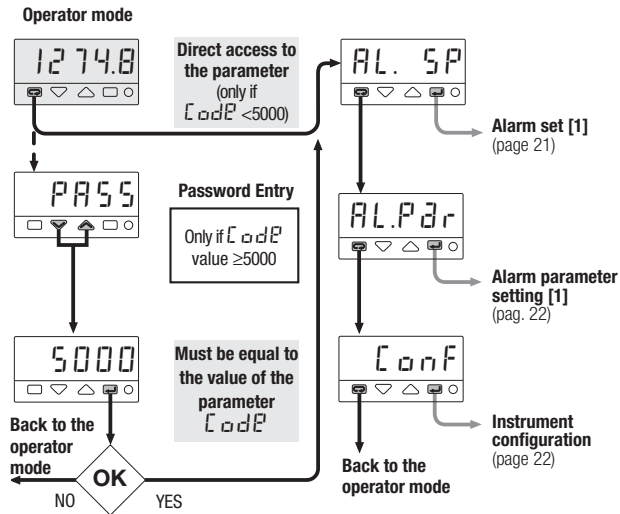

4.3.1 ALARM SET

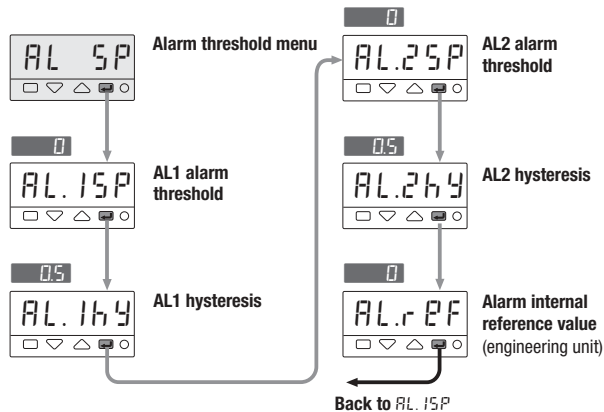
**Note:**

[1] The menu appears only if at least one of the alarms has been configured (except for the sensor break alarm).

4.3.3 ALARMS PARAMETERISATION MENU

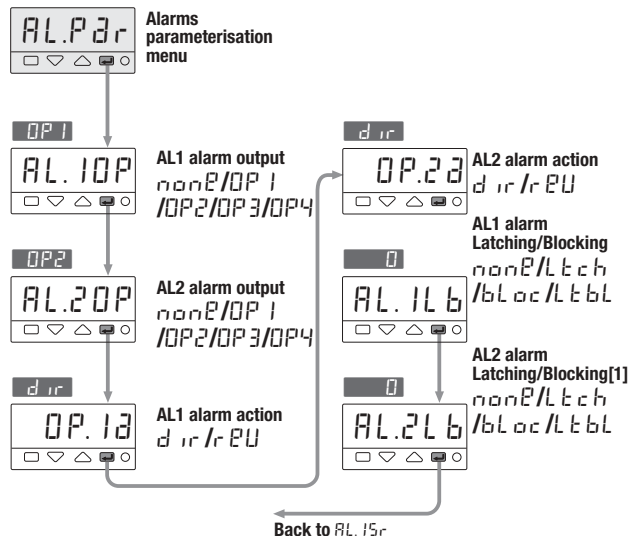
**Note:**

[1] Only those alarms that are configured different than zero are shown during the parameterisation phase (fields **OP** page 17).

4.3.5 CONFIGURATION MENU

When an unconfigured indicator is powered up for the first time, the display shows:



See chapters 3, 3.1 and 3.2 starting from page 14.

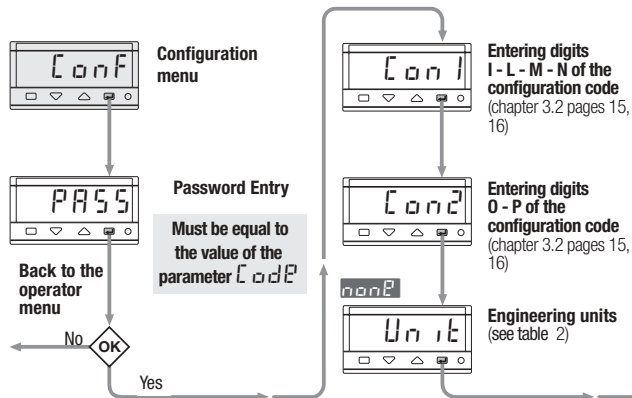

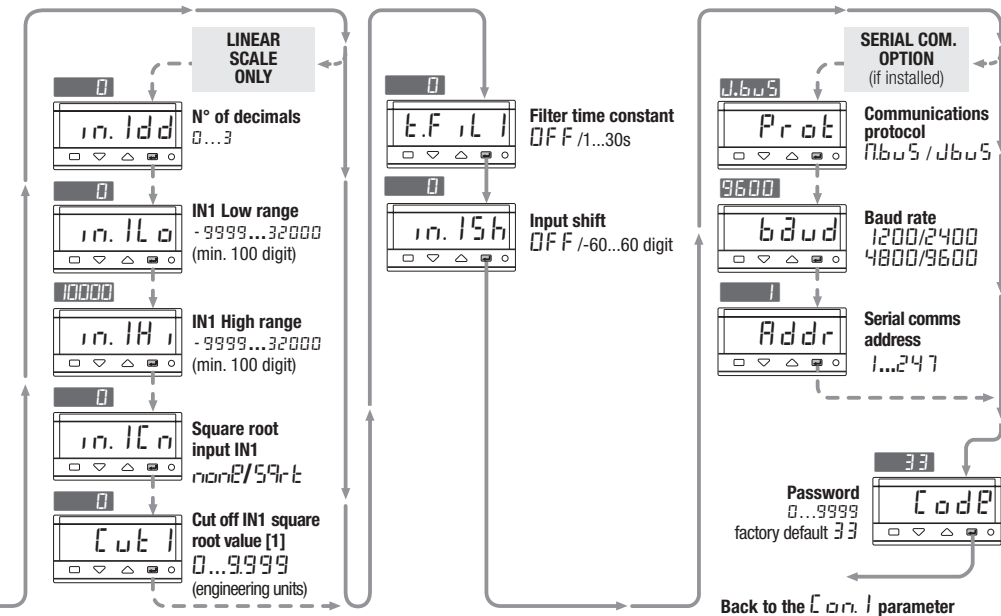
**Table 1 - Engineering units**

| unit | |
|-------|--------------------|
| Value | Description |
| °C | Centigrade degrees |
| °F | Fahrenheit degrees |
| none | none |
| mV | mV |
| V | Volt |
| mA | mA |
| A | Ampere |
| Bar | Bar |
| PSI | PSI |
| Rh | Rh |
| pH | pH |

Note:

[1] Cut off the square root of the input value enables the user to round to zero a result that is too low to be meaningful.

4.4 PARAMETERS DESCRIPTION

For ease of operation of the indicator parameters have been organised in groups (menu), according to their functionality area.

4.4.1 ALARM THRESHOLD MENU

OP1 and OP2 outputs can be used as alarms

it is possible to configure up to 2 alarms: AL1 and AL2 (page 22) selecting for each of them:

- the type and the operating condition of the alarm (page 26);
- the functionality of the alarm acknowledgement (latching) **LtCh** (page 25);
- the blocking function is activated on start up **BLoc** (page 25);
- Sensor break function (page 26);
- Rate alarm (AL1 only) (page 26).

AL1 alarm threshold

AL2 alarm threshold

Parameters to set the threshold of AL1 and AL2 alarms.

The range of the alarm threshold corresponds to the whole span.

When the alarm occurs, the display will show the red LEDs **1** and **2** respectively ON and, when configured, with a change of the display colour (AL1 only).

AL1 alarm hysteresis

AL1 alarm hysteresis

Hysteresis of the threshold of AL1 and AL2 alarms. It is specified as a % of the full scale.

4.4.2 ALARM PARAMETERS CONFIGURATION MENU

AL.1OP AL1 alarm output

AL.2OP AL2 alarm output

These parameters connect each alarm to the output port to be activated when an alarm condition occurs.

Values: none, OP1, OP2.

Default values: AL1: OP1
AL2: OP2.

OP.1a Output OP1 action

OP.2a Output OP2 action

These parameters set the type of action of the output port.

Values: direct (relay-coil excited when in alarm condition), reverse (relay-coil not excited when in alarm condition).

Default values: direct.

AL.1Lb AL1, AL2, latching and

AL.2Lb blocking and blocking function

For each alarm it is possible to select one of the following functions:

none none;

Ltch acknowledge;

bl oc blocking;

Lt.bL latching + blocking

Ltch ALARM ACKNOWLEDGE FUNCTION

Once an alarm occurs, it is indicated on the display until it is acknowledged. To acknowledge an alarm press the \otimes key.

After this operation, the alarm shuts off only when the alarm condition is no longer present.

bl oc START-UP DISABLING

Ramp down

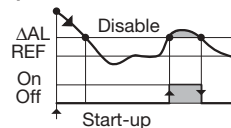

Ramp up

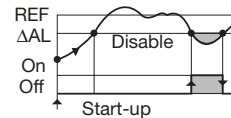

ΔSP Threshold = $SP \pm \text{range}$

4.4.3 CONFIGURATION MENU

[Conf]

1st part of the configuration code

Fields **[I]** and **[L]** allow the selection of type and range of the primary input (IN1 page 16).

Field **[M]** allows the selection of the function mode of the display (page 17).

[Conf2]

2nd part of the configuration code

Fields **[O]** and **[P]** select alarm type and function (page 17).

SENSOR BREAK ALARM FUNCTION

During the configuration phase (page 17) set fields **[O]**, **[P]**, to value 1. When the PV overcomes the sensor range limits, the sensor break alarm intervention is immediate. **When the alarm is no longer present, the alarm stops**

ABSOLUTE ALARM

During the configuration phase (page 17) set fields **[O]** and **[P]** to value 2 (active high) or 3 (active low).

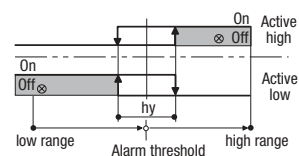

DEVIATION ALARM

During the configuration phase (page 17) set fields **[O]** and **[P]** to value 4 (active high) or 5 (active low).

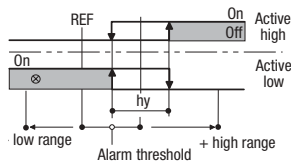

BAND ALARM

During the configuration phase (page 17) set fields **[O]** and **[P]** to value 5 (active in) or 6 (active out).

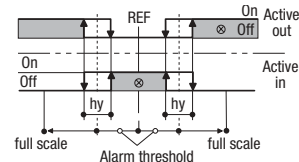

AL1 RATE ALARM FUNCTION

During the configuration phase (page 17) set field **[O]**, to value 8. When the changing rate of the PV connected to the alarm is higher than the specified threshold, AL1 is activated.

The changing rate can be set within the limits: 0.1... 5.0 digit/s.

The alarm will be activated in 1 second if the changing rate is higher than 1 digit/s. At lower rates the alarm activation time increases to up to 6 seconds for a limit change rate of 0.1 digit/s.

Unit**Engineering units**

This parameter allows the user to view the process in the desired engineering unit. When the instrument senses temperature, this parameter allows the conversion between Fahrenheit ($^{\circ}F$) and centigrade ($^{\circ}C$). All the engineering units available are listed at page 23 table 2.

LINEAR SCALE PARAMETERS

The parameters that follow are displayed only when, during the configuration phase, a linear input has been selected for IN1 (files **I** and **L** at page 16).

in.ddd**IN1 Input number of decimals****in.llo****IN1 input low range****in.HHl****IN1 input high range**

These parameters allow the user to set the operating range and the number of decimal point to be displayed for the primary (IN1) input.

in.lcn**IN1 measure square root**

This parameter enables the calculation of the square root of the IN1 measure ($Sqr t =$ enabled, $non E =$ disabled)

cut 1**Cut-off square root result**

This parameter allows the user to round to zero those results that are not meaningful.

Setting range: 0...9999.

Default value: 0.

SERIAL COMMUNICATIONS PARAMETERS (OPTIONAL)

The parameters that follow are displayed only when the optional communications board is installed in the instrument.

Prot**Communications protocol****baud****Baud rate****Addr****Instrument serial address**

Values:

Protocol: Modbus/Jbus.

Baud rate:
200/2400/4800/9600 baud.

Instrument serial address:
1...247

Default values:

Protocol: Jbus.

Baud rate: 9600 baud.

Instrument serial address: 1

SAFETY PARAMETERS**Code****Access code**

This parameter allows the user to change the factory default password ($Code = 33$).

If $Code$ is set to 0 (zero), the access to the instrument is open (no password needed).

If $0 < Code \leq 5000$ only the $CONF$ menu is protected.

Codes higher than 5000 ($5000 \leq Code < 10000$), protect all the 2 main menus of the instrument.

5 DISPLAYS

5.1 DISPLAYING THE PROCESS VARIABLE

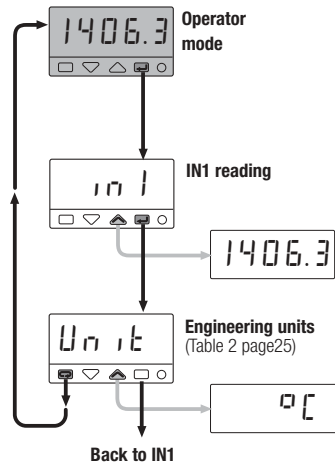

5.2 DISPLAYING THE CONFIGURATION CODES

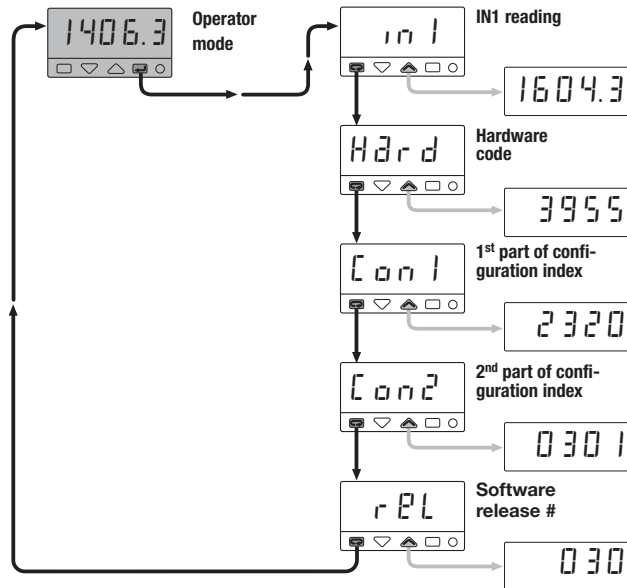

6 COMMANDS

COMMANDS TO THE INDICATOR AND OPERATING PROCEDURE

The commands can be entered in 2 ways:



6.1 KEYPAD

see page 30

- Keypad lock
- Outputs lock



6. SERIAL COMMUNICATIONS

see the manual on this topic



6.1 KEYPAD COMMANDS

6.1.1 KEYPAD LOCK

To lock/unlock the keypad press and hold the keys  and  simultaneously for 2 seconds. To confirm the keypad lock/unlock the display flashes once.

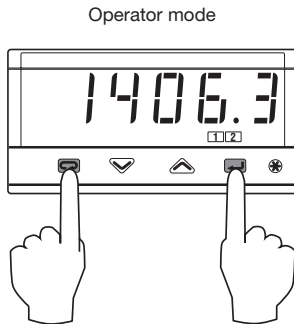

The keypad lock/unlock can also be achieved over serial communications.

 The keypad lock is retained in the event of power failure.



Press simultaneously
for 2 seconds

6.1.2 OUTPUTS LOCK

The outputs are switched to the OFF status by pressing and holding the keys  and  simultaneously for 2 seconds. To confirm the output lock/unlock the display flashes once. To unlock the outputs press the keys simultaneously again.

The output lock/unlock can also be achieved over serial communications.

 The output lock is retained in the event of power failure.

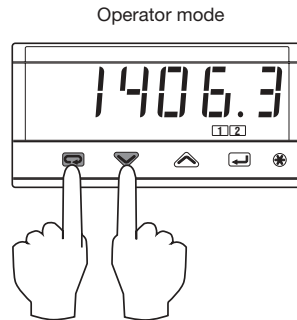

Press simultaneously
for 2 seconds

7 TECHNICAL SPECIFICATIONS

| Features (at 25°C environmental temp.) | Description | | | |
|--|---|--|---|---|
| Total configurability | From keypad or serial communication the user selects: input type, type/functionality and display mode of the alarms | | | |
| IN1 Input (see pages 11,12 and 16) | Common characteristics | A/D converter with resolution of 50000 points Update measurement time: 0.2 seconds Sampling time: 0.5 seconds Input bias: -60...+ 60 digit Input filter: 1...30 seconds (0 = disabled) | | |
| | Accuracy | 0.25% ±1 digits for temperature sensors 0.1% ±1 digits (for mV and mA) | Between 100...240Vac the error is minimal | |
| | Resistance thermometer (for ΔT: R1+R2 must be <320Ω) | Pt100Ω at 0°C (IEC 751) °C/°F selectable | 2 or 3 wire connection Burnout (with any combination) | Max. wire resistance: 20Ω max. (3 wires) Input drift: 0.35°C/10° Env. Temp. <0.35°C/10Ω Wire Res. |
| | Thermocouple | L, J, T, K, S, R, B, N, E, W3, W5 (IEC 584) Rj >10MΩ, °C/°F selectable | Internal cold junction compensation with NTC Error 1°C/20°C ±0.5°C Burnout | Line: 150Ω max. Input drift: <2μV/°C Env. Temp. <5μV/10Ω Wire resistance |
| | DC input current (with 2.5Ω external shunt) | 0... 20mA, 4... 20mA Rj >10MΩ | Burnout. Engineering units Conf. decimal point position Low range -9999... 32000 High range -9999... 32000 | Input drift: <0.1%/20°C Env. Temp. |
| | DC input voltage | 0...50mV, 10...50mV Rj >10MΩ | (min. range of 100 digits) | |
| OP1 output | SPDT relay, 2A/250Vac (4A/120Vac) for resistive load | | | |
| OP2 output | SPST Relay N.O., 2A/250Vac (4A/120Vac) for resistive load | | | |

7 - Technical specification

| Features (at 25°C environmental temp.) | Description | | | | |
|---|---|---|--|-------------------------|---------------------------|
| AL1 - AL2 alarms | Hysteresis 0.1...10.0% c.s. | | | | |
| | Action | Active high | Action type | Changing rate threshold | 0.1...5.0 digit/s |
| | | Deviation threshold | | ±range | |
| | Special functions | | Sensor break | Band threshold | 0...range |
| | | | Acknowledge (latching), activation inhibit (blocking), OR function | Absolute threshold | whole range |
| Serial comm. (option) | RS485 isolated, Modbus/Jbus protocol, 1200, 2400, 4800, 9600 bit/s, 3 wires | | | | |
| Auxiliary Supply | +24Vdc ±20% 30mA max. - for external transmitter supply | | | | |
| Operational Safety | Measure input | Detection of out of range, short circuit or sensor break with automatic activation of the safety strategies and alerts on display | | | |
| | Parameters | Parameter and configuration data are stored in a non-volatile memory for an unlimited time | | | |
| | Access protection | Password to access the configuration and parameter data, keypad lock, outputs lock | | | |
| General characteristics | Power supply (PTC protected) | 100...240Vac (-15...+10%) 50/60 Hz or 24Vac (-25...+12%), 50/60 Hz and 24Vdc (-15...+25%) | | | Power consumption 4W max. |
| | Safety | Compliance to EN61010-1 (IEC 1010 – 1), installation class 2 (2.5kV) pollution class 2, instrument class II | | | |
| | Electromagnetic compatibility | Compliance to the CE standards (see page 2) | | | |
| | UL and cUL Approvals | File 176452 | | | |
| | Protection EN60529 (IEC 529) | IP65 front panel | | | |
| Dimensions | 1/8 DIN - 96 x 48, depth 110 mm, weight 250 g approx. | | | | |

























WARRANTY











We warrant that the products will be free from defects in material and workmanship for 3 years from the date of delivery.

The warranty above shall not apply for any failure caused by the use of the product not in accordance with the instructions contained in this manual.

ICONS TABLE

| Main universal input | |
|---|------------------------|
|  | Thermocouple |
|  | RTD (Pt100) |
|  | Delta Temp (2x RTD) |
|  | mA and mV |
|  | Custom |
|  | Hz |
| Auxiliary input | |
|  | Current transformer |
|  | mA Remote setpoint |
|  | Volt Remote setpoint |
|  | Feedback potentiometer |
| | |

| Digital input | |
|---|---------------------|
|  | Isolated contact |
|  | NPN open collector |
|  | TTL open collector |
| Setpoint | |
|  | Local |
|  | Stand-by |
|  | Keypad lock |
|  | Outputs lock |
|  | Start-up function |
|  | Timer function |
|  | Memorized |
|  | Remote |
|  | Setpoint programmer |

| Digital input connected functions | |
|---|--|
|  | Auto/Manual |
|  | Run, Hold, Reset and program selection |
|  | PV hold |
|  | Setpoint slopes inhibition |
| Output | |
|  | SPST Relay |
|  | Triac |
|  | SPDT Relay |
|  | mA |
|  | mA mV |
|  | Logic |
| | |

ASCON'S WORLDWIDE SALES NETWORK

SUBSIDIARY

FRANCE

ASCON FRANCE

Phone: +33 (0) 1 64 30 62 62

Fax +33 (0) 1 64 30 84 98

AGENCE SUD-Est

Phone: +33 (0) 4 74 27 82 81

Fax +33 (0) 4 74 27 81 71

USA

ASCON CORPORATION

Phone: +1 630 482 2950

Fax +1 630 482 2956

DISTRIBUTORS

ARGENTINA

MEDITECNA S.R.L.

Phone +5411 4585 7005

Fax +5411 4585 3434

FINLAND & ESTONIA

THT CONTROL OY

Phone +358 3 212 9400

Fax +358 3 212 9404

GERMANY

MESA INDUSTRIE ELEKTRONIK GMBH

Phone +49 2365 915 220

Fax +49 2365 915 225

GREECE

CONTROL SYSTEM

Phone +30 31 521 055-6

Fax +30 31 515 495

BRANCH OFFICE

Phone +30 1 646 6276

Fax +30 1 646 6862

PORTUGAL

REGIQUIPAMENTOS LDA

Phone +351 21 989 0738

Fax +351 21 989 0739

SPAIN

INTERBIL S.L.

Phone +34 94 453 50 78

Fax +34 94 453 51 45

BRANCH OFFICE

Phone +34 93 311 98 11

Fax +34 93 311 93 65

Phone +34 918 969 111

Fax +34 918 969 112

SWITZERLAND

CONTROLTHERM GMBH

Phone +41 44 954 37 77

Fax +41 44 954 37 78

TURKEY

KONTROL SISTEMLERI LTD

Phone +90 216 302 19 70-71

Fax +90 216 302 19 72

UNITED KINGDOM

EUKERO CONTROLS LTD

Phone +44 20 8568 4664

Fax +44 20 8568 4115

